

Paper 0123456789

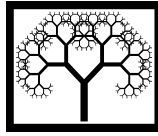

©Civil-Comp Press, 2013

Proceedings of the Fourteenth International Conference on
Civil, Structural and Environmental Engineering Computing,
B.H.V. Topping and P. Iványi, (Editors),
Civil-Comp Press, Stirlingshire, Scotland

Theoretical Models and Numerical Methods for Adaptive Inflatable Structures

C. Graczykowski

**Institute of Fundamental Technological Research
Polish Academy of Sciences, Warsaw, Poland**

Abstract

The paper describes various approaches for mathematical modelling of adaptive inflatable structures (AIS) along with corresponding numerical methods. The introductory part presents a general idea of adaptive impact absorption (AIA) and the concept of inflatable structures equipped with controllable valves serving for internal pressure control. Application of AIS for adaptive absorption of the impact loading is briefly explained. The paper focuses on methods of modelling of inflatable structures, which are based on interaction between solid walls and fluid enclosed inside. Modelling of the solid walls is based on rigid body dynamics or initial boundary value problem of solid mechanics. In turn, modelling of the fluid utilizes either classical equilibrium thermodynamics or Navier-Stokes equations. Consequently, four possible combinations of the above approaches are distinguished, precisely analyzed and applied for modelling of different types of inflatable structures. Each model takes into account controllable valves, which require introducing additional coupling between parameters defining the valves and selected results of the analysis. Corresponding numerical methods include Runge-Kutta methods, finite volume method (FVM) applied for problems with mobile boundaries, classical finite element method (FEM) and finally FEM coupled with FVM. Proposed numerical methods and software tools are utilized for simulation of adaptive pneumatic cylinders, adaptive pneumatic fenders and membrane valves.

Keywords: inflatable structures, impact absorption, fluid-structure interaction

1 The concept of Adaptive Inflatable Structures

Adaptive impact absorption (AIA) [1,2,3] is a contemporary scientific and engineering discipline which belongs to a group of 'smart technologies'. It combines classical impact mechanics with elements of control theory (including optimisation techniques) and contemporary material sciences concerning functional materials.

The essence of AIA is real-time adaptation of energy absorbing structure to actual dynamic loading by changing local mechanical properties of selected elements during impact. In order to execute the adaptation process the structure is equipped with embedded system of sensors, hardware controller and dissipaters with controllable mechanical properties (structural fuses). Consequently, the subsequent stages of adaptation are: i) impact detection and identification, ii) development of the optimal control strategy and iii) its realization with the use of structural fuses. The entire process is conducted in a semi-active way, without supplying large additional energy to the system. Application of the AIA paradigm allows to adjust structure characteristics to actual impact loading, to mitigate its response in optimal way and, in effect, to accommodate to contemporary strict safety requirements.

Nowadays, the design and practical realisation of AIA systems is possible and justified due to a broad accessibility of functional materials and required electronic devices (sensors, actuators and hardware controllers). Adaptive impact absorbing structures are based on miscellaneous adaptation techniques such as application of magneto-rheological fluids, piezoelectric actuators or detachable pyrotechnic connections.

Typical example of AIA system is adaptive landing gear (Fig. 1) where piezoelectric valve adjusts damping characteristics to actual landing conditions in order to reduce total generated grounding force [4]. Another example is adaptive truss structure equipped with structural fuses with controllable yield stress levels, whose proper control allows to dissipate impact energy and mitigate global response of the structure (Fig. 2).

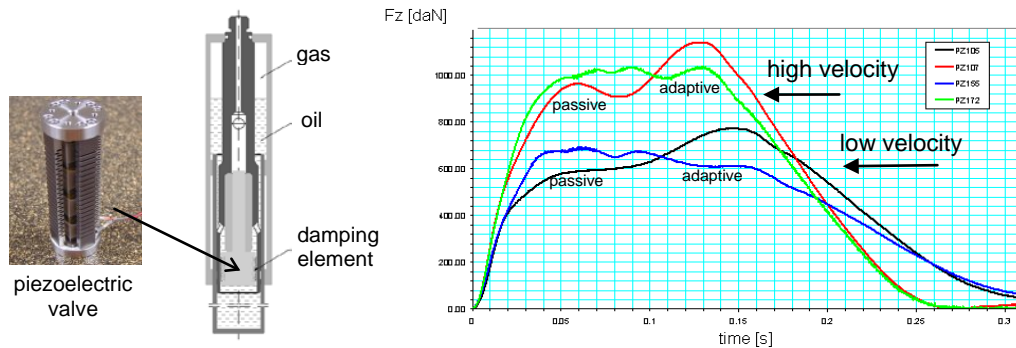

Figure 1: Adaptive landing gear: a) design of the absorber, b) reduction of grounding force obtained during flight tests [4]

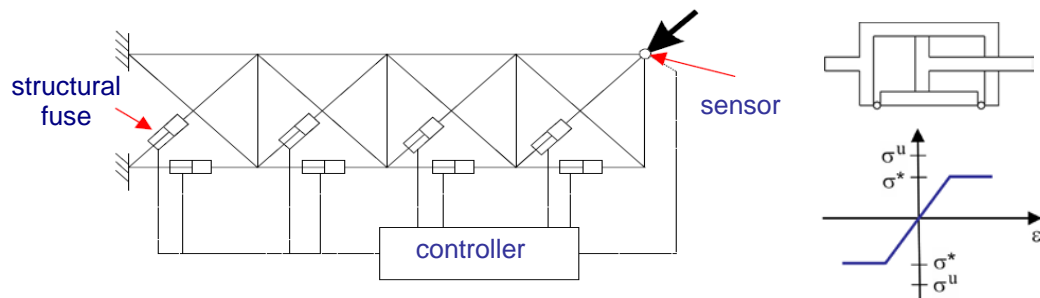

Figure 2: Adaptive truss structure: a) general scheme of the system, b) structural fuses with controllable yield stress levels

On the other hand, one of the classical technologies applied for protection against impact loadings are pneumatic and inflatable structures, which are utilized as energy absorbers in land and water transport, aeronautics and astronautics (Fig. 3). The most common application of this group are airbag systems used in passenger cars to provide safety of the occupants during collisions. Unfortunately, design of most classical pneumatic structures enables only adjustment of initial inflation or initial pressure level. During the impact process they remain passive systems where change of internal pressure is by no means controlled. This indicates that the process of energy dissipation is not optimal and it can be significantly improved by introducing discharge valves precisely controlling actual rate of gas outflow.

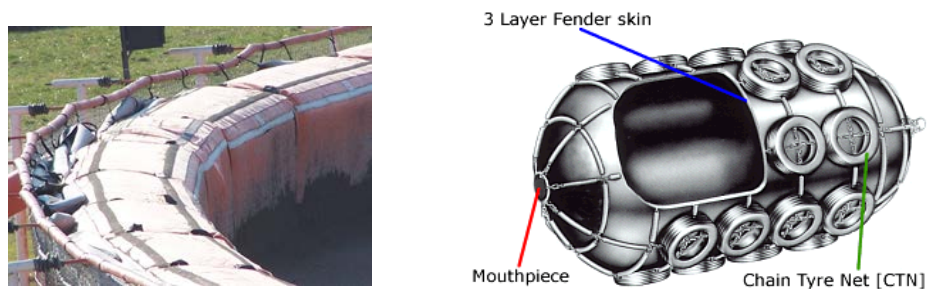

Figure 3: Passive inflatable structures: a) air fences at speedway tracks, b) Yokohama pneumatic fender

Adaptive Inflatable Structures (AIS, [5,6,7]) are innovative pneumatic structures which operate according to the principle of adaptive impact absorption. They are constructed as deformable structures divided into sealed chambers filled with compressed gas and additionally equipped with fast inflators and controllable discharge valves. The concept utilizes controlled transfer and release of gas as an effective technique allowing for real-time adaptation of the energy absorbing structure to actual dynamic loading.

The process of adaptation is performed in several stages. The first stage is impact detection and identification, executed with the use of ultrasonic sensors or dedicated impact sensors (cf. ‘Impactometer’ concept [8]). Recognized impact scenario is utilized by a hardware controller to develop optimal strategy of internal pressure control. At the beginning of impact each chamber of AIS is inflated to appropriate initial pressure in order to provide optimal initial stiffness of the structure. During impact the valves manage flow of the gas between the chambers and its outflow to environment, which allows for precise control of gas pressure in particular parts of the structure during subsequent stages of the process. As a result, dynamic characteristics of the structure can be instantaneously modified and it can be adjusted to actual level of loading. The entire procedure enables optimal dissipation of the impact energy and mitigation of dynamic response of protected structure and impacting object. Hitting object can be stopped by using the whole admissible braking distance, its deceleration can be significantly reduced and its possible rebound can be mitigated. Simultaneously, forces transmitted to impacted structure causing its excessive vibration or local stresses can be minimised.

The form and shape of adaptive inflatable structure depends on its particular application. The inflated structure may act uni-directionally (as cylinder enclosed by piston), it may be a thin-walled aluminium or steel structure or it may be completely pliable cushion made of rubber or fabric. Moreover, AIS may constitute an independent system, it may be attached to impacting object or, alternatively, to protected structure. The examples of AIS are adaptive pneumatic cylinders, adaptive inflatable thin-walled road barriers and doors of passenger cars, adaptive airbags for emergency landing of the flying objects and adaptive fenders for protection of the offshore structures, Figure 4.

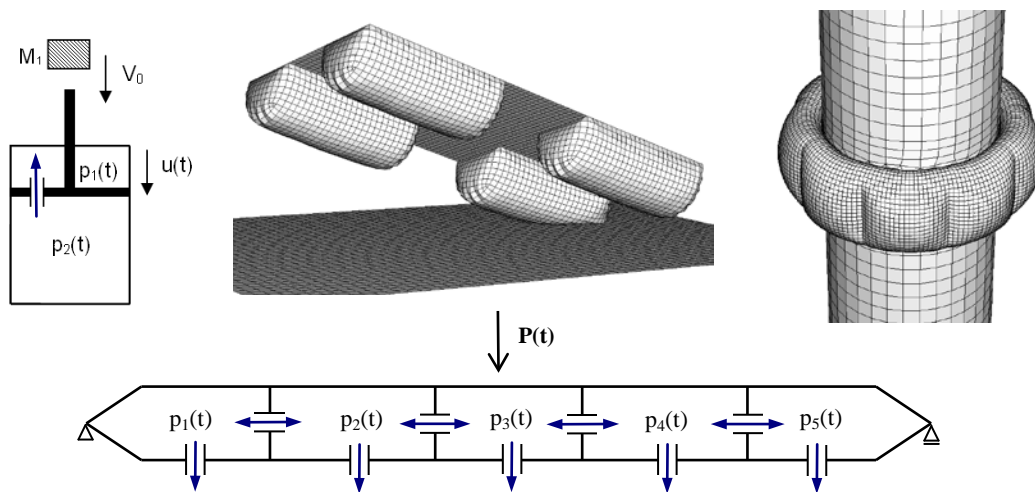

Figure 4: Examples of adaptive inflatable structures: a) adaptive pneumatic cylinders b) emergency airbags , c) pneumatic fender, d) adaptive inflatable barrier [4].

2 Modelling of Adaptive Inflatable Structures

Modelling of inflatable structure subjected to impact loading requires considering the interaction between its walls and fluid enclosed inside. Applied external loading causes large deformation of the structure and change of volume of the internal chambers, which affects gas pressure and enforces its flow. Forces exerted by the compressed gas affect, in turn, deformation of the solid walls and corresponding state of internal stress.

The most precise method of analysing the above coupled problem is the so-called fluid-structure interaction (FSI) [9, 10, 11] where both solid and fluid domains are described by thermo-mechanical conservation laws and moreover appropriate coupling conditions at the interface between domains are taken into account. In the most general FSI approach all quantities of interest (solid density, displacement and temperature, fluid density, velocity and temperature) are assumed to vary in space and time and their rates of change in space and time are related to each other by system of coupled nonlinear partial differential equations. The FSI approach is commonly used in modelling of automotive airbags, especially airbag deployment and out-of-position airbag-occupant collisions, advanced design methods of lightweight structures and modelling of biomechanical problems.

Using the above method for modelling of AIS subjected to impact loading is a challenging task since it requires considering contact problem, large deformation of the solid body causing geometrical and constitutive nonlinearities, effects caused by fluid compressibility and viscosity as well as permanent operation of the controllable valves. Therefore, depending on type of analyzed inflatable structure, simplified models of various complexity can be proposed. Solid part can be considered as:

1. general problem of computational solid mechanics (CSM) - initial boundary value problem (IBVP) described by partial differential equations (PDEs) or
2. problem of rigid body dynamics (RBD) - initial value problem (IVP) described by ordinary differential equations (ODEs).

Similarly, fluid part can be modelled:

1. as general problem of computational fluid dynamics being numerical solution of Navier-Stokes equations (CFD) - IBVP described by PDEs or
2. as problem of classical thermodynamics utilizing assumption of homogeneity of fluid parameters (here referred to as ‘uniform pressure method’, UPM) - IVP described by ODEs.

In each case the solid part of the model has to be coupled with the fluid part. As a result four different mathematical models of inflatable structures can be distinguished (Fig. 5). All these models will be described and analyzed in the subsequent sections of the paper.

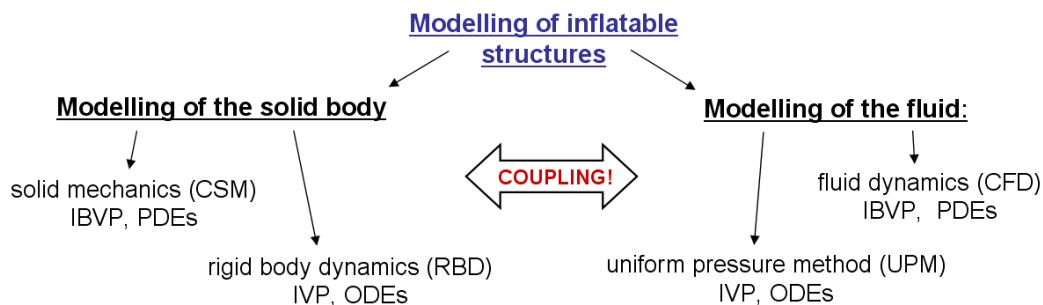

Figure 5: Various approaches for modelling of adaptive inflatable structures

Proposed by the author, systematic approach for the modelling of inflatable structures involves two distinct steps. Initially, theoretical viewpoint is assumed and the most general, abstract model of inflatable structure is derived and gradually simplified. Further this composition is reversed and particular types of inflatable structures are considered with the use of models of increasing complexity (Fig. 6). Herein, the initial theoretical part will be skipped and attention will be focused on mathematical models related to particular engineering problems. The entire approach is extensively presented in the doctoral dissertation of the author [5].

The first type of structures analyzed in this paper are adaptive pneumatic cylinders, which are modelled by the simple approach combining rigid body dynamics and uniform pressure method (‘RBD+UPM’) in case of slow impacts or Navier-Stokes equations (‘RBD+CFD’) in case of fast impacts. In turn, simulation of inflatable thin-walled structures and adaptive airbags requires considering

continuous problem of solid mechanics, however simplified modelling of the fluid can be usually applied ('CSM+UPM'). Eventually, modelling of the controllable valves requires precise approach combining general problem of solid mechanics and Navier-Stokes equations ('CSM+CFD'). Applied control algorithm and its complexity is strongly correlated with the method of modelling. The most advanced control strategies are used for simple models based on uniform pressure method, while the most basic ones are applied for the fully coupled FSI models, see Fig. 6.

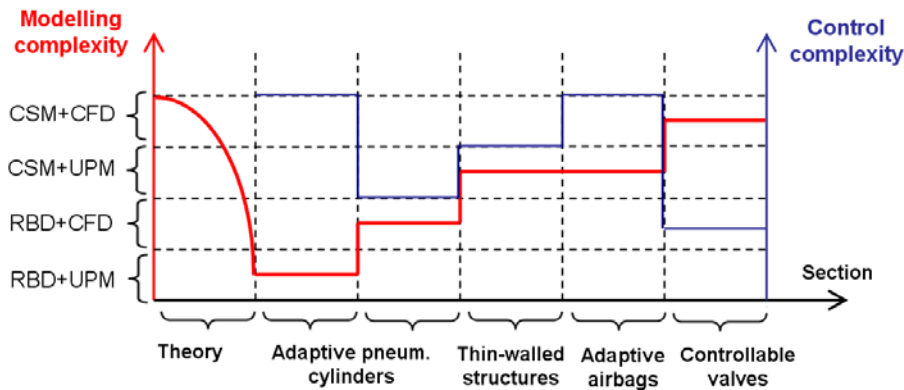

Figure 6: Modelling complexity and control complexity in the subsequent sections

Taking into account operation of controllable valves and introducing adaptation procedures requires complementing the model with a control system. Feed-forward control is reflected in mathematical model by dependency of parameters describing the valve on identified parameters of impact and time. In turn, feedback control results in additional one-way coupling between parameters defining the valve and selected results of the analysis.

Another aspect of inflatable structures simulation is the choice of numerical methods for the solution of formulated mathematical models as well as selection of software for implementation of this methods and for implementation of the control algorithms. In general, simulation of AIS requires ODE solver, finite element method (FEM) solver for solid mechanics problems, finite volume method (FVM) solver for fluid dynamics problems and their common usage. In turn, feedback control loops and control algorithms can be implemented either by means of internal subroutines of applied software or with the use external programme which governs proceeding of the entire simulation. Numerical methods and software applied in following simulations will be described in subsequent sections and further collected and compared in a concluding one.

3 Basic models of adaptive pneumatic cylinders

Adaptive pneumatic cylinders are the simplest type of adaptive inflatable structures. They are composed of single or double chamber cylinder, a piston and a controllable valve, whose opening can be modified depending on actual response of the system. Location of the valve depends on type of the considered absorber and it may enable outflow of gas to environment or flow between the chambers, Fig. 7a,b. The

cylinder is assumed to be subjected to low-velocity impact, i.e. the impact for which wave propagation effects in fluid are negligible.

Basic method of modelling of adaptive pneumatic cylinders considers impacting object and the piston as rigid bodies and assumes uniform pressure, temperature and density of the gas within each chamber. Therefore, the method can be qualified as combined rigid body dynamics and uniform pressure method (RBD+UPM). In this approach all laws governing motion of the piston and behaviour of the fluid are expressed as ordinary differential or algebraic equations.

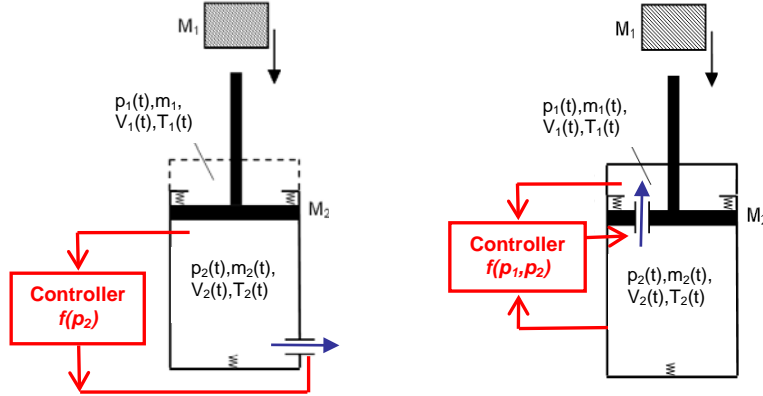

Figure 7: Two basic options for design of adaptive pneumatic cylinder

3.1 Description of the mathematical model

Although two absorbers presented in Figure 7 are characterized by different location of the valve, the corresponding mathematical models are in both cases quite similar. Consequently, both systems will be considered in parallel.

The model is described by equations of motion of the falling mass and the piston, the equation of gas energy balance, the equation of the gas flow and, finally, by ideal gas law. Mechanical part of the model contains two equations:

$$M_1 \frac{d^2 u_1}{dt^2} - M_1 g + F_C = 0 \quad (1)$$

$$M_2 \frac{d^2 u_2}{dt^2} - M_2 g + F_p - F_C - F_D^{TOP} + F_D^{BOT} + F_{fr} = 0 \quad (2)$$

where M_1 and M_2 indicate mass of the falling object and mass of the piston, respectively. Except classical inertia terms, the equations of motion contain contact force F_C which arises during collision of the falling mass with the piston rod, top and bottom delimiting forces F_D^{TOP} , which confine movement of the piston at the end of cylinder stroke and friction force F_{fr} .

The objective of the remaining part of modelling is to determine pneumatic force generated by the absorber in terms of kinematics of the piston and valve opening. Generated pneumatic force F_p can be defined as a difference of pneumatic forces acting on both sides of the piston:

$$F_p = p_2 A_2 - p_1 A_1 - p_A (A_2 - A_1) \quad (3)$$

Gas enclosed in each chamber is described by the ideal gas law, where volume of the chambers V is a function of actual displacement of the piston:

$$p_1 V_1 = m_1 R T_1 \quad \text{where} \quad V_1 = A_1 (h_{01} + u_2) \quad (4a)$$

$$p_2 V_2 = m_2 R T_2 \quad \text{where} \quad V_2 = A_2 (h_{02} - u_2) \quad (4b)$$

The second equation governing change of gas parameters in each chamber is energy conservation law, which involves energy transferred to the system in the form of heat Q , enthalpy of the gas added or removed by the valve flow (H_{in} , H_{out}), gas internal energy U and work done by gas W :

$$dQ + dm_{in} \bar{H}_{in} - dm_{out} \bar{H}_{out} - d(m\bar{U}) - dW = 0 \quad (5)$$

Specific gas enthalpy, specific gas energy and work done by gas are defined as:

$$\bar{H}_{in} = c_p T_{in}; \quad \bar{H}_{out} = c_p T; \quad \bar{U} = c_v T; \quad dW = p dV \quad (6)$$

The form of the enthalpy term arising in the equation of energy balance depends on actual pressure difference on both sides of the valve and the corresponding direction of the gas flow. Providing that a chamber contains a single valve, only one enthalpy term is simultaneously present in the equation of energy balance. Moreover, the flow of heat into or across cylinder walls is described by Newton's law of cooling:

$$\dot{Q} = \lambda A_w (u_2) (T_{wall/ext} - T) \quad (7)$$

where λ indicates mean heat conductivity coefficient and A_w indicates area of the cylinder wall where heat transfer occurs. Finally, flow of gas between compressed chamber and the environment in the first absorber and flow of gas between both chambers in the second absorber (Fig. 7) are described by the equations:

$$\dot{m} = f(p_2, T_2, p_A, T_A, C_{valve}) \quad \text{and} \quad \dot{m} = f(p_2, T_2, p_1, T_1, C_{valve}) \quad (8)$$

Both above relations define dependence of the actual mass flow rate on pressure and temperature of gas on both sides of the valve and introduced parameter defining opening of the valve C_{valve} .

By combining all above equations we obtain mathematical model of the absorber in the form of system of nonlinear ordinary differential equations. In such model interaction between piston motion and fluid response is provided by coupling equation of motion and ideal gas law: motion of the piston changes actual volume of the gas enclosed in both chambers, while actual values of pressures contribute to equation of piston motion.

Modelling of adaptive pneumatic cylinder additionally requires considering operation of the controllable valve which modifies actual rate of gas outflow. In case

of feed forward control system where valve opening is predefined at the beginning of impact the valve coefficient is a function of mass and velocity of the hitting object and it changes during the time of impact. In turn, in case of feedback control system where valve opening depends on actual response of the system (acceleration of the piston, pneumatic force, etc.) the valve coefficient is a function of arbitrary results of the analysis. Mathematically both situations are described by the relations:

$$C_{valve} = f(M_1, V_0, t) \quad \text{and} \quad C_{valve} = f(\ddot{u}_2, F_p, p_2, p_1, T_2, T_1) \quad (9)$$

The latter dependence introduces additional nonlinearity to the governing equations. Due to piecewise definitions of selected quantities (contact force, enthalpy terms) as well as arising multiple nonlinearities the proposed mathematical model of a simple 2DOF system becomes relatively complicated.

3.2 Corresponding numerical methods and software tools

Since mathematical model of adaptive pneumatic cylinder is simply a system of nonlinear ODEs, it can be solved by various numerical methods. Herein, the method chosen for the solution of the derived equations was fourth-fifth order Runge-Kutta-Fehlberg method. This method is not purely implicit or explicit but belongs to the class of embedded Runge-Kutta methods, where two estimates are obtained by using two different linear combinations of the same auxiliary functions. The method appeared to be fast and efficient for the considered strongly nonlinear problem.

The implementation of the numerical models of passive pneumatic absorbers was performed in MAPLE software by introducing appropriate differential equations including piecewise-defined functions, next by solving them by RKF45 method and, finally, by integrating them over time and displacement in order to obtain momentum and energy balances. Moreover, implementation of models of adaptive pneumatic cylinders equipped with controllable valves was performed in the following manners:

1. by application of build-in commands allowing for 'on-line' modification of the coefficient describing valve opening according to actual results of the numerical analysis (inequality-based conditional expressions);
2. by automatic multiple stopping and restarting of the simulation at particular time instants in order to read previously obtained results and to modify valve opening applied in continued analysis accordingly;
3. by establishing connection with MATLAB which allowed for restarting the simulation and for utilising MATLAB optimization procedures included in 'Optimisation Toolbox' and 'Genetic Algorithm Toolbox'.

Simple numerical example concerns application of double chamber pneumatic cylinder as a landing gear of a small aerial vehicle. Described mathematical model based on combination of rigid body dynamics and uniform pressure method was utilized to model the process of landing of the object with two degrees of freedom. Simple control algorithm based on commutative full opening and closing of the valve allowed to maintain constant level of generated pneumatic force and to obtain high efficiency of the absorber, Figure 8.

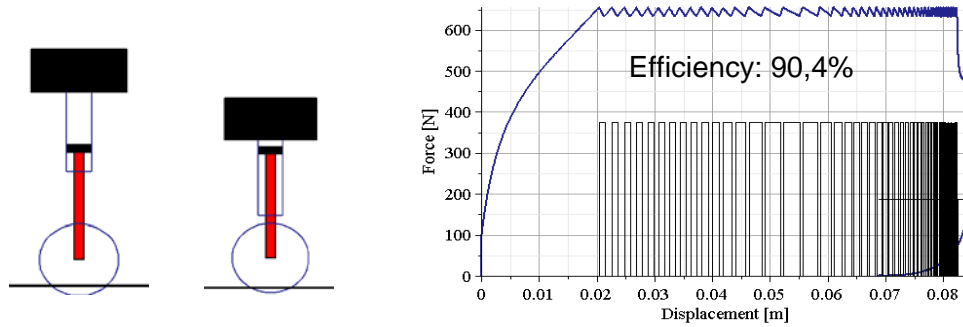

Figure 8: Simulation of the adaptive landing gear with 'RBD+UPM' approach: a) scheme of the analyzed system, b) applied valve opening and generated force

4 CFD models of adaptive pneumatic cylinders

The current section constitutes direct continuation of the previous one since it also concerns modelling and control of the adaptive pneumatic cylinders. The important difference is that now the cylinder will be subjected to high-velocity impact, i.e. the impact for which wave-propagation effects arising in fluid are intrinsic for global response of the absorber. Consequently, uniform pressure method can not be applied for the modelling of the system.

Proposed, more precise approach to simulation of pneumatic cylinders assumes modelling of the response of gas inside the chambers as initial boundary value problem of fluid mechanics described by Navier-Stokes equations. The piston will still be treated as a rigid body and its motion will be considered as rigid body dynamics. Therefore, the approach can be referred to as coupled rigid body and computational fluid dynamics (RBD+CFD). In this approach mathematical model of the system is a combination of ordinary and partial differential equations.

4.1 Description of the mathematical model

In contrast to previously described approach, the proposed method of simulation utilizes space discretization of both solid and fluid domain. Both single and double chamber cylinder consist of a single fluid region Ω_F , a region of solid walls Ω_W and a region of a piston Ω_P , Figure 9.

Basic assumptions for the proposed mathematical model is large stiffness of the cylinder walls and uni-directional movement of the piston. Consequently, cylinder walls are assumed to be fixed in space and equations describing their mechanical equilibrium are not included into mathematical model. Displacement of the piston is governed by a simple equation of motion. Simultaneously, it is assumed that transfer of heat through cylinder walls and the piston occurs so corresponding equations of energy balance are taken into account. In turn, Navier-Stokes equations for the fluid are considered in a full form including balance of mass, momentum and energy.

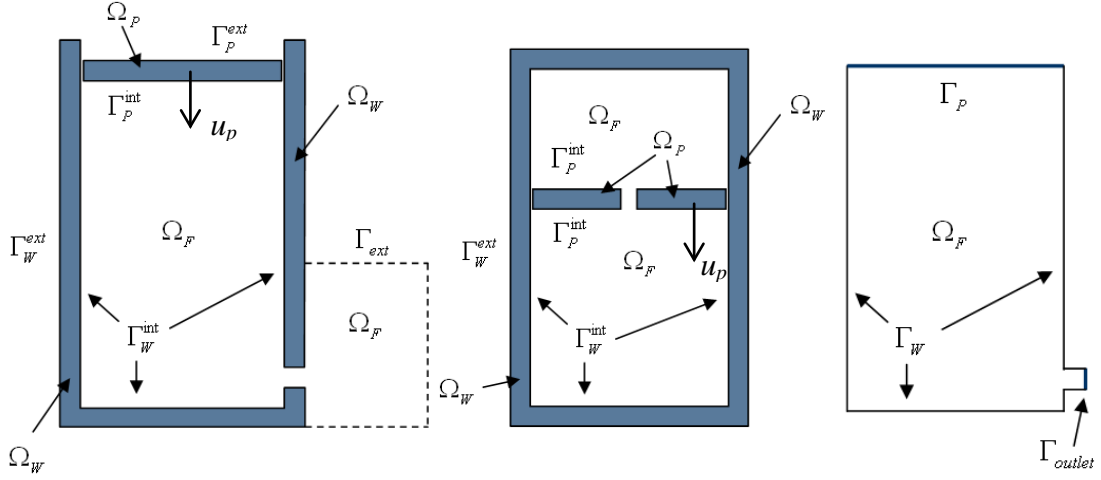

Figure 9: CFD models of pneumatic cylinders: a,b) models including heat transfer through cylinder walls, c) model with adiabatic walls and outlet boundary condition

The equations governing solid part of the system, i.e. equation of piston motion and energy conservation law take the following forms:

$$M \frac{d^2 u_p}{dt^2} - Mg + \int_A (\boldsymbol{\sigma}_f(\Gamma_p^{\text{int}}) \mathbf{n}) \cdot \mathbf{n} dA + F_{fr} = 0 \quad \text{at } \Gamma_p^{\text{int}} \quad (10a)$$

$$\frac{D}{Dt} (\rho_s J e) = -\text{Div}(J \mathbf{q}_s \mathbf{F}^{-T}) \quad \text{in } \Omega_W \cup \Omega_P \quad (10b)$$

Equation of piston motion contains classical terms resulting from inertia, gravitation and friction as well as additional term indicating force exerted by compressed gas (fluid stresses integrated over piston boundary), which provides coupling of the fluid and solid part of the problem. The energy conservation law involves internal energy e and heat flux \mathbf{q}_s but it neglects terms corresponding to work done by internal stresses and body forces. The equation is written in a general form in a Lagrangian reference frame, however deformation gradient \mathbf{F} and Jacobian J are equal to unity and thus it can be simplified to a heat transfer equation.

Since the shapes of domains occupied by fluid change during the process arbitrary Lagrangian-Eulerian (ALE) approach has to be used for description of fluid kinematics. Consequently, Navier-Stokes equations governing response of the fluid are formulated in ALE reference frame χ and they take into account arbitrary movement of the fluid coordinate system defined by displacement field $\hat{\mathbf{u}}_f$:

$$\frac{\overline{D}(J_\chi \rho_f)}{Dt} + \overline{\text{Div}} \left[\rho_f J_\chi \left(\mathbf{v}_f - \frac{\partial \hat{\mathbf{u}}_f}{\partial t} \right) \mathbf{F}_\chi^{-T} \right] = 0 \quad (11a)$$

$$\frac{\overline{D}(\rho_f J_\chi \mathbf{v}_f)}{Dt} + \overline{\text{Div}} \left[\rho_f J_\chi \mathbf{v}_f \otimes \left(\mathbf{v}_f - \frac{\partial \hat{\mathbf{u}}_f}{\partial t} \right) \mathbf{F}_\chi^{-T} \right] = \overline{\text{Div}} [J_\chi \boldsymbol{\sigma}_f^T \mathbf{F}_\chi^{-T}] + \rho_f J_\chi \mathbf{f} \quad (11b)$$

$$\begin{aligned}
& \frac{\overline{D}(\rho_f J_\chi E_f)}{\overline{D}t} + \overline{\text{Div}} \left[\rho_f J_\chi E_f \left(\mathbf{v}_f - \frac{\partial \hat{\mathbf{u}}_f}{\partial t} \right) \mathbf{F}_\chi^{-T} \right] = \\
& = -\overline{\text{Div}} [J_\chi \mathbf{q}_f \mathbf{F}_\chi^{-T}] + \overline{\text{Div}} [J_\chi (\boldsymbol{\sigma}_f \mathbf{v}_f) \mathbf{F}_\chi^{-T}] + \rho_f J_\chi \mathbf{f} \cdot \mathbf{v}_f
\end{aligned} \tag{11c}$$

The above equations utilize standard notation for fluid density ρ_f , velocity \mathbf{v}_f and total internal energy E_f . The occurrence of ALE gradient \mathbf{F}_χ and Jacobian J_χ result from the presence of the arbitrary displacement field $\hat{\mathbf{u}}_f$. Both these quantities assume simplified form due to unidirectional compression of the fluid domain. The equation governing deformation of the fluid coordinate system (and corresponding deformation of the fluid mesh) has a general form:

$$\frac{\partial \hat{\mathbf{u}}_f}{\partial t} = \mathbf{D}(\hat{\mathbf{u}}_f) \quad \text{in } \Omega_f \tag{12}$$

where \mathbf{D} is an arbitrary differential operator, which in considered case contains spatial derivatives exclusively in the direction defined by the piston movement.

Interaction between fluid and solid part of the problem occurs at internal boundary of the piston. Besides force coupling arising in the equation of piston motion, the movement of the piston enforces fluid velocity at fluid-piston interface and changes geometry of the fluid domain. Coupling conditions for fluid velocity are defined separately for the components perpendicular and parallel to the piston:

$$\mathbf{v}_{f\perp} = v_p, \quad \mathbf{v}_{f\parallel} = 0 \quad \text{on } \Gamma_p^{\text{int}} \tag{13}$$

and they cause that horizontal velocity of the fluid is identical as velocity of the piston v_p and that fluid sticks to the piston. In turn, coupling conditions for the field $\hat{\mathbf{u}}_f$ defining deformation of the fluid coordinate system read:

$$\hat{\mathbf{u}}_{f\perp} = u_p, \quad \hat{\mathbf{u}}_{f\parallel} = 0 \quad \text{on } \Gamma_p^{\text{int}} \tag{14a}$$

$$\hat{\mathbf{u}}_f = 0 \quad \text{on } \Gamma_{W_bottom}^{\text{int}} \quad \text{and} \quad \hat{\mathbf{u}}_{f\perp} = 0 \quad \text{on } \Gamma_{W_lateral}^{\text{int}} \tag{14b}$$

and they indicate that fluid mesh is compressed by movement of the piston and slides over lateral walls of the cylinder. Additionally, thermal coupling conditions have to be defined at the internal boundaries of the cylinder walls:

$$T_s = T_f \quad \text{and} \quad \mathbf{q}_s \cdot \mathbf{n} = \mathbf{q}_f \cdot \mathbf{n} \quad \text{on } \Gamma_W^{\text{int}} \cup \Gamma_p^{\text{int}} \tag{15}$$

The above model has to be complemented with classical thermal boundary conditions for the solid body defined at external edges of the cylinder and classical boundary conditions for the fluid. Moreover, initial conditions for the fluid and for the solid body have to be defined.

Presented above mathematical model of pneumatic cylinder can be simplified by neglecting modelling of heat transfer through cylinder walls and by assuming that the walls are adiabatic, see Figure 9c. In such a case, the only equation governing

solid part of the system is equation of piston motion and moreover thermal boundary and coupling conditions are excluded from the model. The second simplification concerns modelling the outflow from the single-chamber cylinder and replacing part of the external fluid region by outlet boundary condition defined as:

$$\mathbf{v}_f = \tilde{\mathbf{v}}_f \quad \text{or} \quad \boldsymbol{\sigma}_f \mathbf{n} = -p^{ext} \mathbf{n} \quad \text{on} \quad \Gamma_V \quad (16)$$

Modelling of the adaptive pneumatic cylinder subjected to high velocity impact additionally requires taking into account controllable outflow of gas from the chambers. In general, such phenomenon be modelled by three following methods:

1. change of the value of boundary condition applied at outlet,
2. change of the width of the orifice where the outflow occurs (Fig. 10a),
3. change of the position of the valve head (Fig. 10b).

Since in adaptive cylinder gas outflow has to be continuously modified during the impact process, the second and the third method require introducing mobile boundaries of the outflow region and corresponding deformation of the adjacent fluid mesh. (Fig. 10). Moreover, in case when adaptation of the absorber utilizes feedback control system the actual width of the orifice or actual position of the valve head depend on arbitrary actual response of the system.

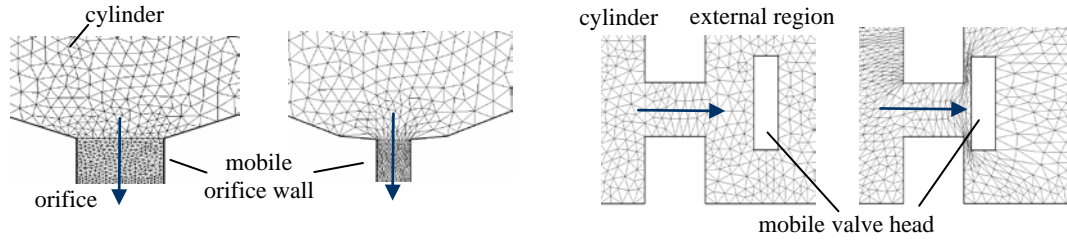

Figure 10: Modelling of the controllable outflow from the cylinder: a) change of the of the orifice width, b) change of the valve head position

Eventually, the proposed CFD model of adaptive pneumatic cylinder differs from classical CFD problem in two manners. At first, the model contains a mobile boundary with displacement defined by the equation of piston motion. At second, the outflow of gas is externally controlled in order to enable the adaptation process.

4.2 Corresponding numerical methods and software tools

Derived mathematical model of adaptive pneumatic cylinder is composed of system of PDEs describing the fluid and single ODE describing motion of the piston. Since the core of the model is fluid dynamics problem described by Navier-Stokes equations, a typical approach is time-averaging of the governing equations and decomposition of the considered fluid fields into mean values and their fluctuation (RANS method). The following step is a choice of appropriate turbulence models. Since derived N-S equations contain non-negligible convective terms, the preferred numerical method is finite volume method (FVM). In turn, equation of piston motion can be integrated by arbitrary numerical method such as Euler method.

Implementation of the above model of pneumatic cylinder can be performed with the use of arbitrary CFD software which supports deforming fluid domains and ALE approach. Herein, the model was implemented in commercial software ANSYS CFX, while time integration of the equation of piston motion and its coupling with Navier-Stokes equations was programmed by CFX script language (CEL). Feedback control system was implemented by linking CFX with MATLAB and by performing multiple automatic restarts of CFD analysis in order to modify outflow from the cylinder according to the assumed adaptation strategy.

The first numerical example is a simulation of passive cylinder subjected to fast impact and it is aimed at comparison of time-history of pressure exerted on piston for various impact velocities, Fig. 11. The second example presents application of feedback control algorithm, which modifies actual width of the orifice and allows to maintain constant pneumatic force during the second stage of impact, Fig. 12.

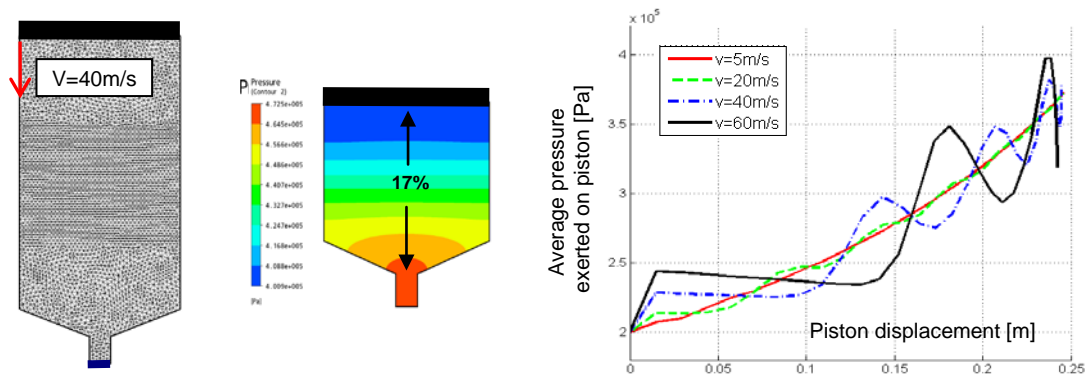

Figure 11: Simulation of passive pneumatic cylinder with 'RBD+CFD' approach

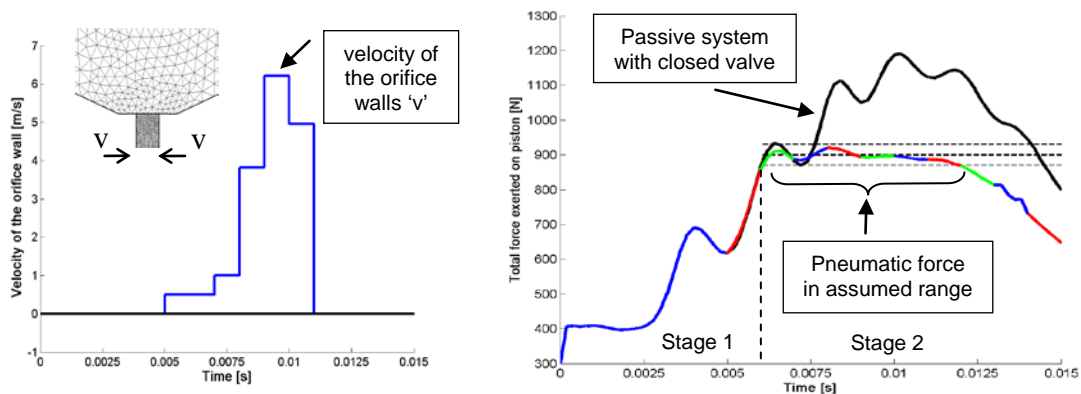

Figure 12: Simulation of adaptive pneumatic cylinder with 'RBD+CFD' approach: implementation of control algorithm aimed at maintaining constant level of force

5 Models of deformable inflatable structures

The following type of considered inflatable structures are structures composed of fully deformable compartment and multiple pressure chambers (e.g. inflatable thin-walled structures made of aluminium or steel, adaptive multi-chamber airbags made

of fabric or adaptive fenders made of rubber). Exemplary design of inflatable multi-chamber road barriers and doors of the passenger car is presented in Figure 13.

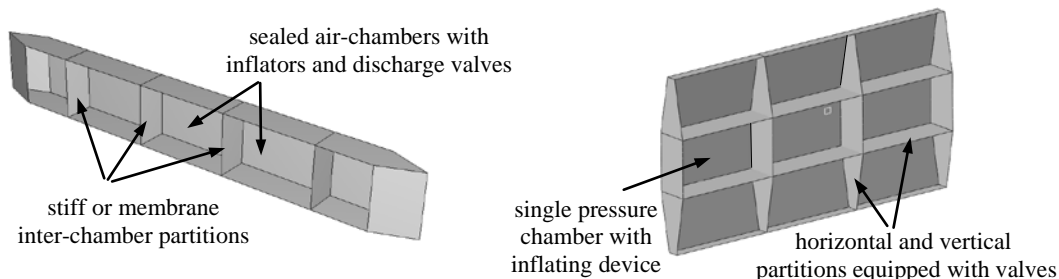

Figure 13: Multi-chamber inflatable thin-walled structures [6]

Mechanics of deformable walls of inflatable structure will be modelled as IBVP of solid mechanics, possibly including the problem of heat transfer. The fluid part will be modelled by assuming homogeneity of gas parameters in each chamber. Consequently, the approach can be qualified as combined solid mechanics and uniform pressure method (CSM+UPM). Mathematical model of the system again comprises both partial and ordinary differential equations. Coupling of the solid and fluid occurs at the boundaries of the fluid chambers. Pressure exerted by fluid and its temperature are applied as boundary conditions for the solid. Moreover, solid deformation changes actual volume of the fluid chambers and together with solid heat flux at the interface contributes to the equation of fluid energy balance.

5.1 Description of the mathematical model

The task undertaken in this section is to derive matrix-based method describing dynamics of deformable inflatable structure composed of finite number of air chambers and controllable valves located between them. The problem of modelling heat transfer inside solid part of the model will be omitted and heat transfer between fluid chambers will be modelled by Newton's law of cooling.

Let us consider the system containing i chambers, k internal and external walls allowing for heat transfer and equipped with j valves serving for gas transfer and corresponding mass and enthalpy exchange. Description of multi-chamber AIS as a set of chambers and connections between them allows to define the whole system as oriented graph.

We will denote gas pressure, gas temperature, mass of the gas in a single chamber and chamber volume by vectors $\mathbf{p}, \mathbf{T}, \mathbf{m}, \mathbf{V}$ and expanded vectors \mathbf{p}^{exp} and \mathbf{T}^{exp} including parameters of the environment. Connections between the chambers indicating the possibility of mass and heat exchange will be defined by allocation matrices $\mathbf{L}_{i,j}$ and $\tilde{\mathbf{L}}_{i,k}$ and expanded allocation matrices $\mathbf{L}_{i+1,j}^{\text{exp}}$ and $\tilde{\mathbf{L}}_{i+1,k}^{\text{exp}}$. Each column of the allocation matrix contains two nonzero elements (-1 and 1) at rows representing connected chambers. The above matrices fully define topology of the system and thus they can be effectively utilized during formulating equations governing pneumatic part of the problem.

Dynamics of multi-chamber inflatable structure will be described in finite element method notation. General form of finite element equation of motion reads:

$$\mathbf{M}\ddot{\mathbf{u}} + \mathbf{C}\dot{\mathbf{u}} + \mathbf{K}(\mathbf{u})\mathbf{u} = \mathbf{F}(\mathbf{p}^{\text{exp}}, \mathbf{u}) + \mathbf{F}_I \quad (17)$$

where $\mathbf{M}, \mathbf{C}, \mathbf{K}$ indicate mass, damping and stiffness matrices of the solid body, respectively and \mathbf{u} denotes vector collecting subsequent degrees of freedom. Impact loading can be modelled by right-hand side force vector \mathbf{F}_I , by initial conditions or by contact defined between the inflatable structure and other object. Moreover, vector $\mathbf{F}(\mathbf{p}^{\text{ext}}, \mathbf{u})$ represents forces exerted by fluid on solid walls of inflatable structure and therefore it provides mechanical coupling between solid and fluid. The interaction of structure and gas during large deformation can be correctly taken into account only by assembling equilibrium equations in actual configuration so equation of motion has to be considered in a nonlinear form.

The remaining part of the mathematical model will concern the balance of mass of the fluid and the balance of energy for each chamber. Each balance equation will be combined with the equation defining flow of the gas between the chambers.

Global balance of mass of the fluid can be formulated by using allocation matrix $\mathbf{L}_{i,j}$, vector indicating unknown mass flow rates between the chambers \mathbf{q} and vector indicating inflow rate from inflators \mathbf{q}^{inf} :

$$\dot{\mathbf{m}} - \mathbf{L}\mathbf{q} = \mathbf{q}^{\text{inf}} \quad \text{or} \quad \dot{m}_i - L_{ij}q_j = q_i^{\text{inf}} \quad (18)$$

Pressure differences between connected chambers and between selected chambers and environment $\Delta\mathbf{p}$ will be expressed by the equation:

$$(\mathbf{L}^{\text{exp}})^T \mathbf{p}^{\text{exp}} = \Delta\mathbf{p} \quad \text{or} \quad L_{ji}^{\text{exp}} p_i^{\text{exp}} = \Delta p_j \quad (19)$$

and the dependence between mass flow rate of gas \mathbf{q} and pressure difference $\Delta\mathbf{p}$ will be defined by linear relation:

$$\mathbf{q} = \Delta\mathbf{p} / \mathbf{C} \quad \text{or} \quad q_j = \Delta p_j / C_j \quad (20)$$

where \mathbf{C} is a vector defining openings of valves. Equations 18-20 can be rearranged into a single equation:

$$\dot{\mathbf{m}} - \mathbf{L} \frac{(\mathbf{L}^{\text{exp}})^T \mathbf{p}^{\text{exp}}}{\mathbf{C}} = \mathbf{q}^{\text{inf}} \quad \text{or} \quad \dot{m}_i - L_{ij} \frac{L_{ji}^{\text{exp}} p_i^{\text{exp}}}{C_j} = q_i^{\text{inf}} \quad (21)$$

which, by using the ideal gas law, can be expressed exclusively in terms of volume of the chambers, gas pressures and gas temperatures.

In turn, global equation of energy balance takes the form:

$$\dot{\mathbf{Q}} + \dot{\mathbf{H}} - \dot{\mathbf{U}} - \dot{\mathbf{W}} = \mathbf{0} \quad \text{or} \quad \dot{Q}_i + \dot{H}_i - \dot{U}_i - \dot{W}_i = 0 \quad (22)$$

and it involves energy transferred in the form of heat \mathbf{Q} , energy transferred in the form of enthalpy $\hat{\mathbf{H}}$, change of internal energy \mathbf{U} and work done by gas \mathbf{W} . All components of this equation can be expressed in terms of basic parameters of the gas. In order to define total heat flux \mathbf{Q} we will apply equation of global balance of heat which utilizes allocation matrix $\tilde{\mathbf{L}}$ and vector $\tilde{\mathbf{q}}$ collecting unknown heat fluxes between particular chambers:

$$\dot{\mathbf{Q}} - \tilde{\mathbf{L}}\tilde{\mathbf{q}} = \mathbf{0} \quad \text{or} \quad \dot{Q}_i - \tilde{L}_{ik}\tilde{q}_k = 0, \quad (23)$$

definition of temperature differences between adjacent chambers :

$$(\tilde{\mathbf{L}}^{\text{exp}})^{\text{T}} \mathbf{T}^{\text{exp}} = \Delta \mathbf{T} \quad \text{or} \quad \tilde{L}_{ki}^{\text{exp}} T_i^{\text{exp}} = \Delta T_k \quad (24)$$

and definition of the corresponding heat fluxes $\tilde{\mathbf{q}}$:

$$\tilde{\mathbf{q}} = (\mathbf{A}\boldsymbol{\lambda})\Delta \mathbf{T} \quad \text{or} \quad \tilde{q}_k = (A\boldsymbol{\lambda})_k \Delta T_k \quad (25)$$

where the term $\mathbf{A}\boldsymbol{\lambda}$ indicates product of the area of the wall separating the cavities and heat conductivity coefficient. Finally, the equation governing global balance of heat transferred between the chambers takes the form:

$$\dot{\mathbf{Q}} = \tilde{\mathbf{L}}(\mathbf{A}\boldsymbol{\lambda})(\tilde{\mathbf{L}}^{\text{ext}})^{\text{T}} \mathbf{T}^{\text{ext}} \quad \text{or} \quad \dot{Q}_i = \tilde{L}_{ik}(A\boldsymbol{\lambda})_k \tilde{L}_{ki}^{\text{ext}} T_i^{\text{ext}} \quad (26)$$

Similarly, in order to define total enthalpy flux $\hat{\mathbf{H}}$ we will apply equation of global balance of enthalpy formulated with the use of vector $\hat{\mathbf{q}}$ indicating flux of enthalpy between the chambers and vector $\hat{\mathbf{q}}^{\text{inf}}$ representing enthalpy submitted by inflators:

$$\hat{\mathbf{H}} - \mathbf{L}\hat{\mathbf{q}} = \hat{\mathbf{q}}^{\text{inf}} \quad \text{or} \quad \hat{H}_i - L_{ij}\hat{q}_j = \hat{q}_i^{\text{inf}} \quad (27)$$

and definition of the enthalpy flux, which is proportional to pressure difference, specific heat and temperature of the flowing gas:

$$\hat{q} = \frac{\Delta p}{\mathbf{C}} c_p \mathbf{T}^* \quad \text{or} \quad \hat{q}_k = \frac{\Delta p_j}{C_j} c_p T_j^* \quad (28)$$

Finally, the equation governing global balance of enthalpy transferred between the chambers reads:

$$\hat{\mathbf{H}} = \mathbf{L} \frac{(\mathbf{L}^{\text{ext}})^{\text{T}} \mathbf{p}^{\text{ext}}}{\mathbf{C}} c_p \mathbf{T}^* + \hat{\mathbf{q}}^{\text{inf}} \quad \text{or} \quad \hat{H}_i = L_{ij} \frac{L_{ji}^{\text{ext}} p_i^{\text{ext}}}{C_j} c_p T_i^* + \hat{q}_i^{\text{inf}} \quad (29)$$

By introducing the above derived balances of heat (Eq. 26) and enthalpy (Eq. 29) into global energy balance (Eq. 22) we obtain a single equation:

$$\tilde{\mathbf{L}}(\mathbf{A}\lambda)(\tilde{\mathbf{L}}^{ext})^T \mathbf{T}^{ext} + \mathbf{L} \frac{(\mathbf{L}^{ext})^T \mathbf{p}^{ext}}{\mathbf{C}} c_p \mathbf{T}^* + \hat{\mathbf{q}}^{inf} = \dot{\mathbf{m}}_V \mathbf{T} + \mathbf{m} \dot{\mathbf{C}}_V \mathbf{T} + \mathbf{p} \dot{\mathbf{V}} \quad (30)$$

Again, by using ideal gas law the above equation can be expressed exclusively in terms of volume of the chambers, gas pressures and gas temperatures.

Ultimately, mathematical model of multi-chamber inflatable structure in ‘CSM+UPM’ approach is described by standard nonlinear equation of motion (Eq.17) complemented with equation defining global balance of mass of the fluid (Eq. 21) and equation defining global balance of fluid energy (Eq. 30). Since volumes of the chambers are functions of structure deformation, the only additional unknowns are pressures and temperatures of gas in each chamber and the proposed model constitutes closed system of equations.

Modelling of adaptive deformable inflatable structures requires considering controllable valves and control algorithms aimed at adjusting actual gas outflow from particular chambers. Similarly as previously, both feed-forward and feedback control can be applied. In mathematical model the control system is reflected in vector \mathbf{C} defining opening of the valves. In case of feed-forward control system it contains functions of time, while in case of feedback control systems - functions depending on actual kinematics of the impacting object or global response of the structure (e.g. average pressure p_{mean} or actual stroke d):

$$\mathbf{C} = \{f_1(t), f_2(t), \dots, f_j(t)\} \quad \text{or} \quad \mathbf{C} = \mathbf{f}(\ddot{u}_2, p_{mean}, d) \quad (31)$$

The second dependency introduces additional nonlinearities to the system of governing equations and substantially complicates derived mathematical model.

5.2 Corresponding numerical methods and software tools

Mathematical model resulting directly from the CSM+UPM approach is composed of partial differential equations describing the solid body and ordinary differential equations describing fluid enclosed in particular chambers. Consequently, a classical way of solving solid mechanics problem based on Lagrangian description of deformation and finite element method was applied, cf. Sect. 5.1. Additional ODEs describing the fluid were incorporated into finite element procedure.

At first, the above model was implemented with the use of implicit FEM solver ABAQUS Standard, which possess basic capabilities for the modelling of fluid-filled cavities [13]. The additional features of the model were implemented by Fortran subroutines (URDFIL, UTEMP). At second, the model was implemented in explicit FEM solver ABAQUS Explicit, which offers wide range of possibilities for the modelling of fluid-filled structures and, moreover, is well suited for simulation of fast dynamic events and large deformations. Implementation of control strategies was performed in the following manners:

1. in case of ABAQUS Standard models the feedback control was obtained by utilizing Fortran subroutines (URDFIL, DISP, UFIELD) interacting with the simulation and allowing for changing conditions of the gas flow,

- In case of ABAQUS Explicit models the feedback control was obtained by establishing connection to MATLAB, which allowed for multiple restart of the analysis and for application of built-in optimisation procedures.

Proposed approach was applied to develop numerical models of inflatable barriers, airbags and fenders. Presented numerical example concerns simulation of adaptive pneumatic fender subjected to the impact of a ship, Figure 14a. The example clearly depicts the influence of applied valve opening on the level of ship deceleration and proves the advantages of real-time control strategy, Figure 14b.

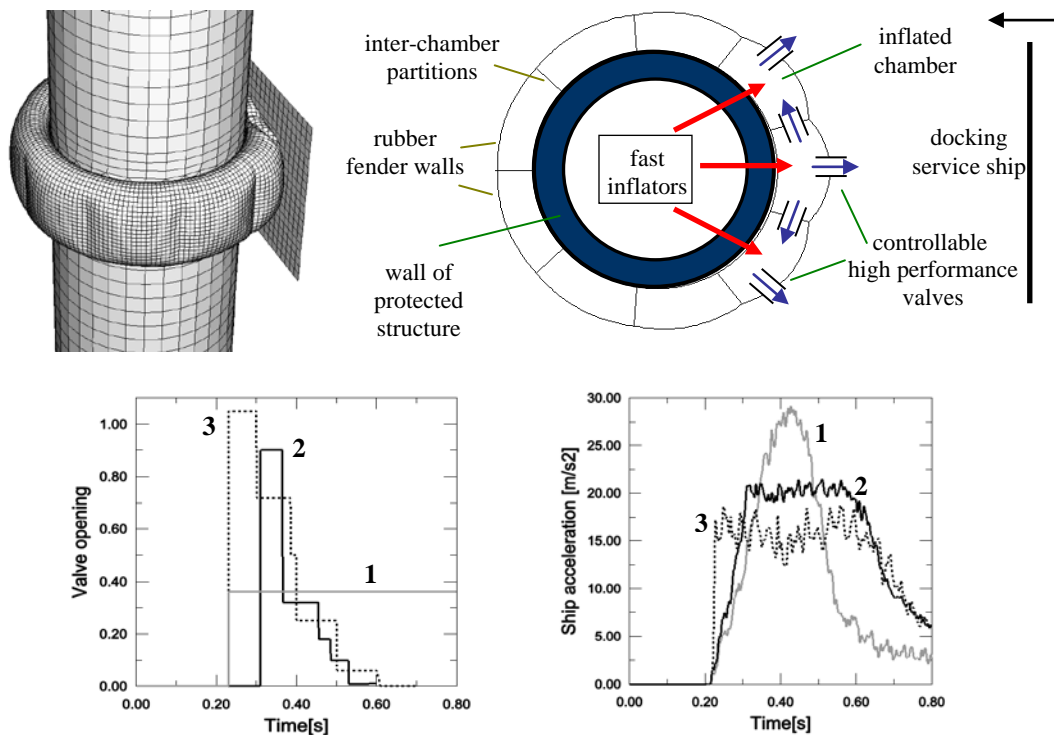

Figure 14: Simulation of adaptive pneumatic fender subjected to ship impact [7] (1- constant opening of the valve, 2 - change of valve opening during the impact process, 3 - additional initial inflation and change of valve opening)

6 Fully coupled models of controllable valves

The last section of the paper does not concern modelling of the following type of inflatable structure but instead it discusses modelling of high performance valves which are used to control actual outflow of gas from inflated chambers. The analyzed patented concept is a self-closing membrane valve [12], in which membrane elements are deformed by forces exerted by the flowing fluid. In the first stage of operation (valve opening) the controlling ring is released, the external membrane is expanded by pressure of gas and the flow is opened (Fig. 15a,b). The second stage of operation (valve closing) effectively utilizes difference of pressure inside and outside balloon-shaped internal membrane and its gradual expansion which enables the process of blocking the flow (Fig. 15b,c).

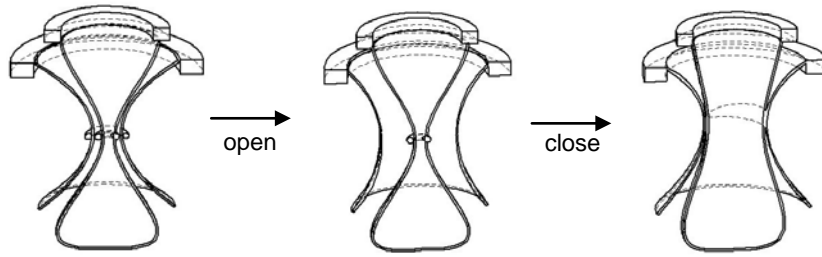

Figure 15: The concept of self-closing membrane valve [12]

Modelling of the above membrane valve requires precise simulation of the fluid flow and its influence on deformation of the membrane. Consequently, the model of the valve will involve full coupling of structural and fluid mechanics. Deformation of membrane will be modelled as initial boundary value problem of solid mechanics and flow of the fluid will be modelled as initial boundary value problem of fluid mechanics. Due to applied methodology, the approach will be referred to as coupled (computational) solid mechanics and fluid dynamics (CSM+CFD). Mathematical model of the system will consist exclusively of partial differential equations.

6.1 Description of the mathematical model

The model applied for simulation of valve closing is composed of internal balloon-shaped membrane located within the outflow channel confined by rigid walls (external boundaries of the fluid domain), Figure 16. Inlet and outlet boundary conditions are defined at top and bottom edges of the considered fluid domain. At the initial configuration the valve remains partially open and outflow of the gas is possible.

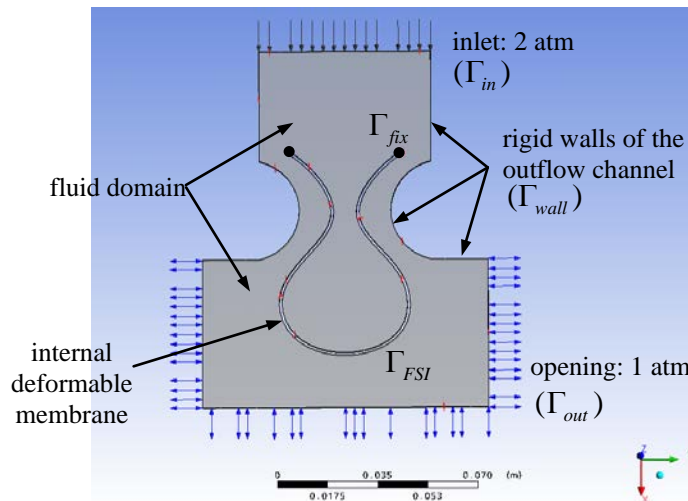

Figure 16: Self-closing membrane valve: numerical model of the system

Mathematical model is formulated by using ‘conforming boundary’ approach. Kinematics of solid is described in a classical manner in Lagrangian reference

frame. Since the solid body deforms and shape of domain occupied by fluid changes during the process an arbitrary Lagrangian-Eulerian (ALE) description of fluid kinematics has to be applied.

The model of the structural part of the problem is based exclusively on equations of mechanical equilibrium and it neglects heat transfer through membrane and the corresponding equation of internal energy balance. Moreover, membrane is modelled as a thin solid body without any kinematic assumptions of membrane theory. Fluid flow is modelled by compressible, viscous Navier-Stokes equations involving balance of mass, momentum and internal energy. The complete system of equations governing the problem reads:

$$\frac{D}{Dt}(J\rho_s\mathbf{v}_s) = \nabla \cdot (J\boldsymbol{\sigma}_s^T \mathbf{F}^{-T}) + \rho_s J_\chi \mathbf{f} \quad \text{in } \Omega_s \quad (32)$$

$$\frac{\overline{D}(J_\chi \rho_f)}{Dt} + \nabla_\chi \cdot \left[\rho_f J_\chi \left(\mathbf{v}_f - \frac{\partial \hat{\mathbf{u}}_f}{\partial t} \right) \mathbf{F}_\chi^{-T} \right] = 0 \quad \text{in } \Omega_f \quad (33)$$

$$\frac{\overline{D}(\rho_f J_\chi \mathbf{v}_f)}{Dt} + \nabla_\chi \cdot \left[\rho_f J_\chi \mathbf{v}_f \otimes \left(\mathbf{v}_f - \frac{\partial \hat{\mathbf{u}}_f}{\partial t} \right) \mathbf{F}_\chi^{-T} \right] = \nabla_\chi \cdot [J_\chi \boldsymbol{\sigma}_f^T \mathbf{F}_\chi^{-T}] + \rho_f J_\chi \mathbf{f} \quad \text{in } \Omega_f \quad (34)$$

$$\begin{aligned} & \frac{\overline{D}(\rho_f J_\chi E_f)}{Dt} + \nabla_\chi \cdot \left[\rho_f J_\chi E_f \left(\mathbf{v}_f - \frac{\partial \hat{\mathbf{u}}_f}{\partial t} \right) \mathbf{F}_\chi^{-T} \right] = \\ & = -\nabla_\chi \cdot [J_\chi \mathbf{q}_f \mathbf{F}_\chi^{-T}] + \nabla_\chi \cdot [J_\chi (\boldsymbol{\sigma}_f \mathbf{v}_f) \mathbf{F}_\chi^{-T}] + \rho_f J_\chi \mathbf{f} \cdot \mathbf{v}_f + \rho_f J_\chi h \quad \text{in } \Omega_f \end{aligned} \quad (35)$$

In the above equations the indices 's' and 'f' denote solid and fluid, respectively. The symbol D/Dt stands for time derivative in the Lagrangian coordinate system, while the symbol \overline{D}/Dt stands for time derivative in the arbitrary Lagrangian-Eulerian coordinate system χ . The meaning of the other quantities is the same as introduced in Sect. 4.

Interaction between solid and fluid part of the problem occurs at the fluid/solid interface. Classical mechanical coupling conditions concern fluid and solid velocities and equilibrium of the interface and they are complemented with boundary condition for the fluid heat transfer:

$$\mathbf{v}_f = \mathbf{v}_s \quad \text{and} \quad \boldsymbol{\sigma}_s \mathbf{n} = \boldsymbol{\sigma}_f \mathbf{n} \quad \text{on } \Gamma_{FSI}, \quad \mathbf{q}_f \cdot \mathbf{n} = 0 \quad \text{on } \Gamma_{FSI} \quad (36)$$

Additionally, mathematical model of the system has to include equation governing motion of the fluid coordinate system (and the corresponding motion of the fluid mesh $\hat{\mathbf{u}}_f$):

$$\frac{\partial \hat{\mathbf{u}}_f}{\partial t} = \mathbf{D}(\hat{\mathbf{u}}_f) \quad \text{in } \Omega_f \quad (37)$$

where \mathbf{D} is an arbitrary differential operator. The corresponding kinematic conditions for deformation of the fluid mesh involve conformity with displacement of the membrane at fluid-solid interface and zero displacement at external edges of

the considered fluid domain:

$$\hat{\mathbf{u}}_f = \mathbf{u}_s \quad \text{on } \Gamma_{FSI} \quad \text{and} \quad \hat{\mathbf{u}}_f = 0 \quad \text{on } \Gamma_{wall} \cup \Gamma_{ext} \quad (38)$$

The equations 37 and 38 provide that deformation of fluid mesh can be determined during numerical analysis and it depends on actual deformation of the membrane. The proposed model has to be complemented with appropriate mechanical boundary conditions for the membrane as well as mechanical and thermal boundary conditions for the fluid. Finally, initial conditions have to be imposed on the velocity of the membrane, parameters of the fluid and mesh deformation.

Modelling of the controllable valve requires introduction of the additional, active element which enables controlling operation of the valve and thus also allows for controlling actual conditions of the fluid flow. Two distinct models of the controllable membrane valve were considered:

- valve with active linking element located in the middle of membrane (modelled as additional solid region), Figure 17a;
- valve with active covering element located above membrane (modelled as void region inside fluid domain), Figure 17b.

The main idea behind two above models is that in the first case the control is executed by modifying element belonging to solid part of the problem, while in the second case - by modifying element belonging to fluid part of the problem. Introduction of feedback control requires additional dependence between active element of the valve and arbitrary response of the system (so called 'control coupling'). As a result mathematical model of the system contains both 'classical coupling' which is two-directional and concerns fluid and solid quantities at the interface, as well as 'control coupling' which is one-way relationship between parameter describing active element of the valve and selected results of the analysis.

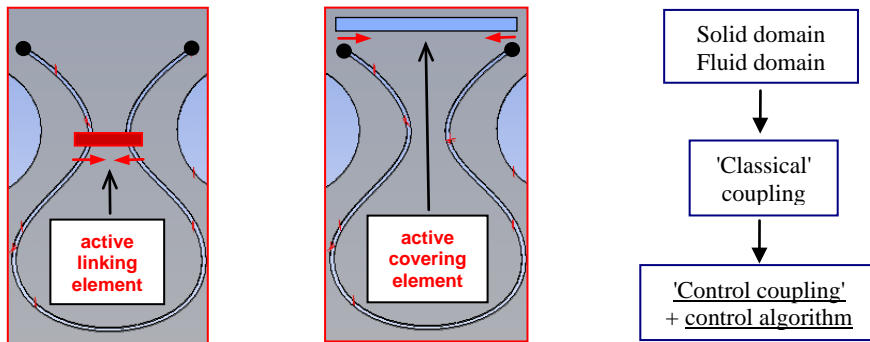

Figure 17: a) Membrane valve with active linking element, b) membrane valve with active covering element, c) general scheme of the proposed approach

The 'control coupling' may concern arbitrary quantities referring to fluid or solid domain, such that four different possibilities can be distinguished, Figure 18. Control coupling together with control algorithm allow to introduce feedback control in a fully coupled fluid-structure interaction problem.

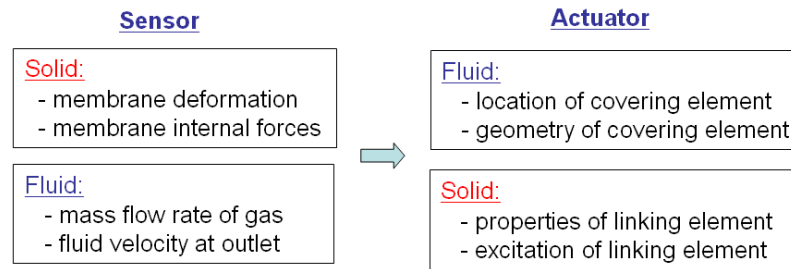

Figure 18: Typical quantities used as sensors and actuators in feedback control

6.2 Corresponding numerical methods and software tools

Derived mathematical model is a system of partial differential equations: a single equation describing membrane and Navier-Stokes equations describing the fluid. Since equations referring to both parts of the problem are of different type, the classical approach is to use FEM for solid mechanics problem, FVM for fluid mechanics problem and a coupling algorithm ('partitioned approach').

Consequently, proposed numerical solution is based on coupling of two distinct solvers for solid and fluid mechanics. The solver used for solid part is ANSYS Structural, while the solver used for fluid part is ANSYS CFX. Coupling of both problems is executed by using ANSYS Multi-field Code Coupling (MFX). The main features of the numerical solution are the following:

1. solid part: solution of solid mechanics problem by finite element method and an implicit scheme of integration of equations of motion;
2. fluid part: solution of the CFD problem by finite volume method with vertex-centred discretization and a 'coupled algebraic multigrid' for solving governing equations [14];
3. coupling scheme: strong coupling of the partitioned solvers which requires equilibrium of each point located at the fluid-solid interface at every coupling step.

Simple numerical example concerns the process of membrane valve closing. Obtained results indicate that after release of the clamping element the internal membrane is expanded by pressure of gas and the valve is being gradually closed.

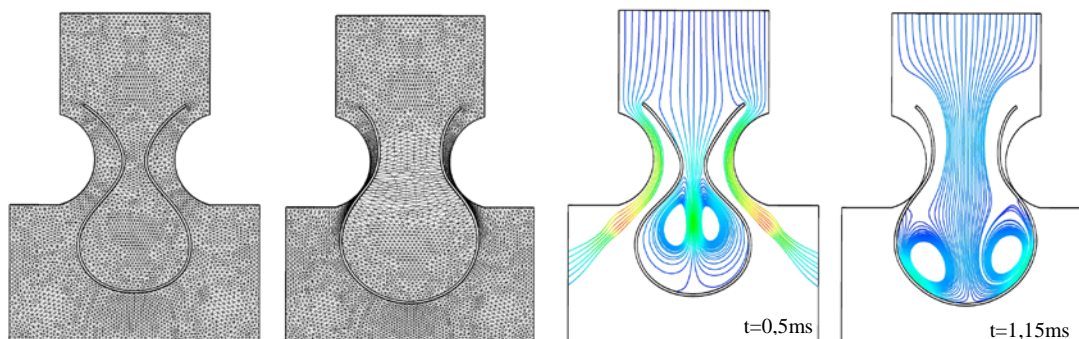

Figure 19: Two-dimensional simulation of membrane valve by ALE method:
 a) deformation of the fluid mesh, b) streamlines of the fluid flow.

Modelling of the controllable membrane valve was conducted with the use of the above coupling of solid and fluid dynamics software and additionally implemented 'software controller', which provides the control coupling and executes feedback control loop. The 'software controller' stops coupled analysis, reads result files from solid and fluid solvers, performs calculations according to implemented control algorithm, processes appropriate input files of solid and fluid solvers and, finally, restarts the analysis. The 'software controller' was implemented:

- by using internal subroutines of fluid or solid solver (method applicable only when the coupling concerns quantities governed by the same solver, i.e. for solid-solid or fluid-fluid couplings),
- by using external software (e.g. MATLAB) which governs the entire proceeding of coupled simulation (method also applicable when exchange of data between fluid and solid solver is required).

Presented numerical example concerns controllable valve in which Young modulus of membrane is modified depending on actual total mass flow rate of the fluid at outlet, Figure 20. At the beginning of simulation the Young modulus of membrane is relatively low, membrane expands and mass flow rate of gas decreases, Fig. 21. When the flow rate drops below a certain level, the Young modulus of membrane is substantially increased which prevents further expansion of the membrane, causes its gradual contraction (Fig. 21a) and stops decreasing of total mass flow rate of fluid (Fig. 21b).

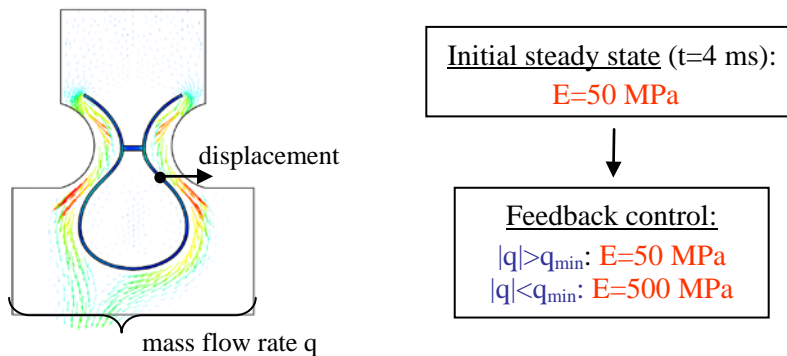

Figure 20: Fluid-solid control coupling: scheme of the applied procedure.

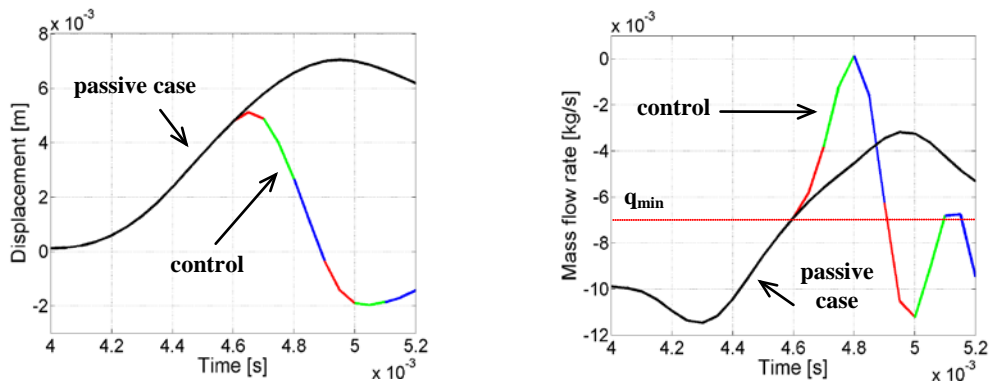

Figure 21. Fluid-solid control coupling: a) measured vertical displacement, b) resulting mass flow rate of the fluid at outlet.

7 Conclusions

Adaptive inflatable structures are innovative smart structures, which consist of sealed pressure chambers and controllable valves. They can adapt to actual impact loading by real-time operation of the valves and corresponding control of internal pressure during impact.

Analysis of adaptive inflatable structures is a challenging task since it requires considering the interaction between deformation of solid walls, response of gas enclosed inside and operation of controllable valves. Consequently, modelling of AIS requires combining rigid body dynamics, solid mechanics, thermodynamics, fluid dynamics and elements of control theory. Resulting models of adaptive inflatable structures are interesting from both mechanical and mathematical point of view. They include ordinary and partial differential equations of a various type as well as feedback control loops.

Distinct models have to be used for modelling of various types of inflatable structures, i.e. pneumatic cylinders subjected to slow and fast impacts, deformable inflatable structures (thin-walled barriers or airbags) and pneumatic valves, see Figure 22. Finding numerical solution of the corresponding governing equations requires miscellaneous numerical methods including Runge-Kutta methods, finite volume method and finite element method. Consequently, each type of the considered problem requires different numerical software for the purpose of modelling and for the purpose of control, Figure 22.

Model	Solid	Fluid	Numerical method	Modelling software	Control software
Pneumatic cylinder UPM	RBM	UPM	Runge-Kutta	Maple	Maple / Matlab
Pneumatic cylinder CFD	RBM	CFD	FVM	CFX	CEL+Matlab
Inflatable barrier	CSM	UPM	Explicit FEM	ABAQUS XPL	Matlab
Adaptive airbags	CSM	UPM	Implicit FEM Explicit FEM	ABAQUS STD ABAQUS XPL	Fortran Matlab
Membrane valve	CSM	CFD	FEM + FVM	ANSYS +CFX	CEL+Matlab

Figure 22. Various approaches, numerical methods and software tools applied for modelling and control of particular types of AIS

Presented in the paper methods of modelling and simulation of adaptive inflatable structures reveal the beauty and abundance of mechanical models and the diversity of corresponding numerical methods.

Acknowledgements

This project was financed from the funds of the National Science Centre (Poland) allocated on the basis of the decision number DEC- 2012/05/B/ST8/02971.

Financial support of the National Center for Research and Development (project Innovative, high performance valves for adaptive pneumatic impact absorbers LIDER/24/130/L-3/11/NCBR/2012) is gratefully acknowledged.

References

- [1] J.Holnicki-Szulc (Ed.), "Smart Technologies for safety engineering", Chapter 5: Adaptive Impact Absorption, Willey, 2008
- [2] J.Holnicki-Szulc, C.Graczykowski, G.Mikułowski, A.Mróż, P.Pawłowski, "Smart Technologies for Adaptive Impact Absorption", Solid State Phenomena, vol. 154, 2009
- [3] J.Holnicki-Szulc, C.Graczykowski, J.Grzędziński, G.Mikułowski, A.Mróż, P.Pawłowski, R.Wiszowaty, "Adaptive Impact Absorption - the concept, simulations and potential applications", 5th International Conference on Protection of Structures against Hazards, November 15-16, 2012, Singapore
- [4] Adaptive Landing Gears for Improved Impact Absorption, ADLAND, EU FP6 project IST-FP6-2002-Aero-1-502793-STREP; <http://smart.ippt.gov.pl/adland>
- [5] C.Graczykowski, "Inflatable Structures for Adaptive Impact Absorption", PhD thesis, IPPT PAN, Warsaw, 2011
- [6] C.Graczykowski, J.Holnicki-Szulc, "Optimization of dynamic properties of adaptive pressurized structures subjected to impact loads", 2nd Conference on Smart Materials and Structures, 18-21 July 2005, Lisbon, Portugal
- [7] C.Graczykowski, J.Holnicki-Szulc, "Protecting offshore wind turbines against ship impacts by means of Adaptive Inflatable Structures", Shock and Vibration, vol. 16, no.4, IOS Press, Netherlands, 2009
- [8] K.Sekuła, C.Graczykowski, J.Holnicki-Szulc, "On-line impact load identification, Shock and Vibration", doi:10.3233/SAV-2012-0732
- [9] H.J.Bungartz, M.Mehl, M.Schafer (Eds), "Fluid - Structure Interaction II: Modelling, Simulation, Optimization", Springer, Berlin, 2010
- [10] S.Hartmann, A.Meister, M.Schafer, S.Turek (Eds), Proceeding of International Workshop on Fluid-Structure Interaction: Theory, numerics and applications, Kassel University Press, 2009
- [11] Computational Mechanics, Volume 43, Number 1, 2008, Special issue: Fluid-Structure Interaction
- [12] European patent pending EP2113430, "Drivable valve to be used in gas bags in particular and method for restricting the flow of the fluid". Authors: M.Ostrowski, P.Pawłowski, C.Graczykowski
- [13] ABAQUS, User's manual, ver 6.11
- [14] ANSYS CFX, Theory manual, ver 12.0