

Stochastic model of p53 regulation

Krzysztof Puszynski, Beata Hat, Tomasz Lipniacki

Why p53?

- p53 is a transcription factor that regulates hundreds of responsible for
 - DNA repair,
 - cell cycle arrest
 - apoptosis (programmed cell death)
- p53 is mutated (or absent) in 50% of solid tumors, in other 50% gene controlling p53 are mutated.
- 50 000 experimental citations, less than 100 theoretical papers

It is difficult !

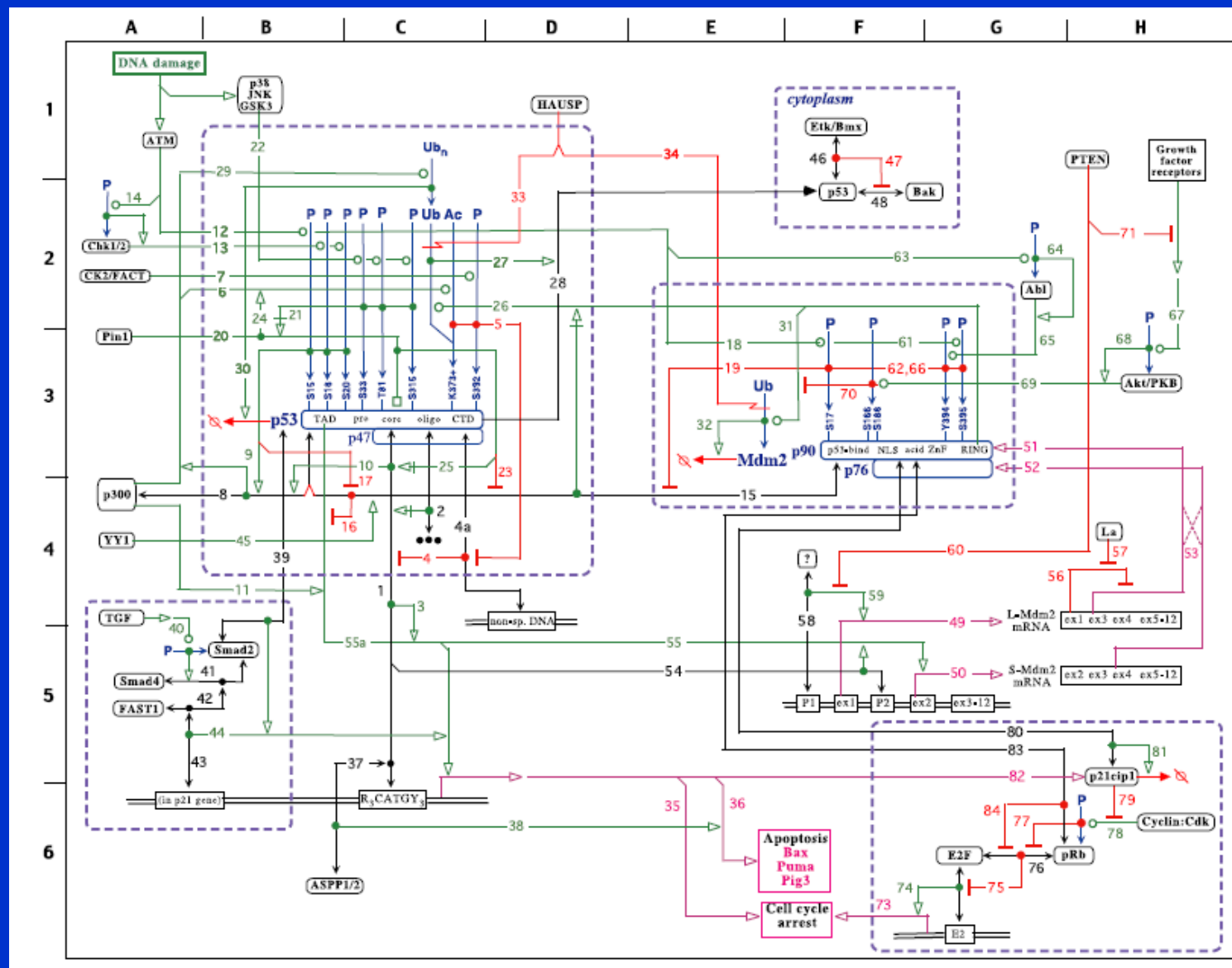

10 or more feedbacks,
100 or more components,
Stochastic noise

Kohn and Pommier 2005

Experiments

- proteins and mRNA levels, kinase activity
- System perturbations
 - gene, mRNA, protein knockouts
 - protein (gene) modifications
- Various stimulation protocols

Single cell experiment

(Geva-Zatorski et al. 2006)

- continuous oscillations for 72 hour after gamma irradiation

- fraction of oscillating cells increases with gamma dose reaching about 60% for 10 Gy.

- even after 10 Gy dose, analyzed cells proliferated

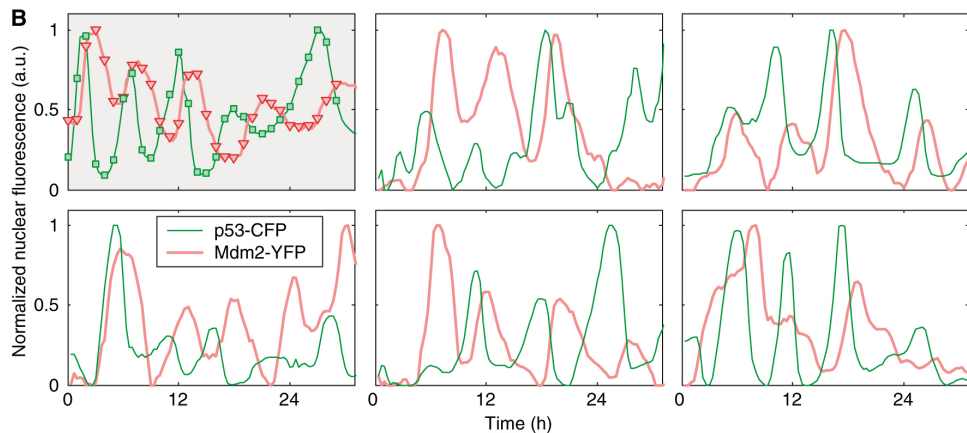
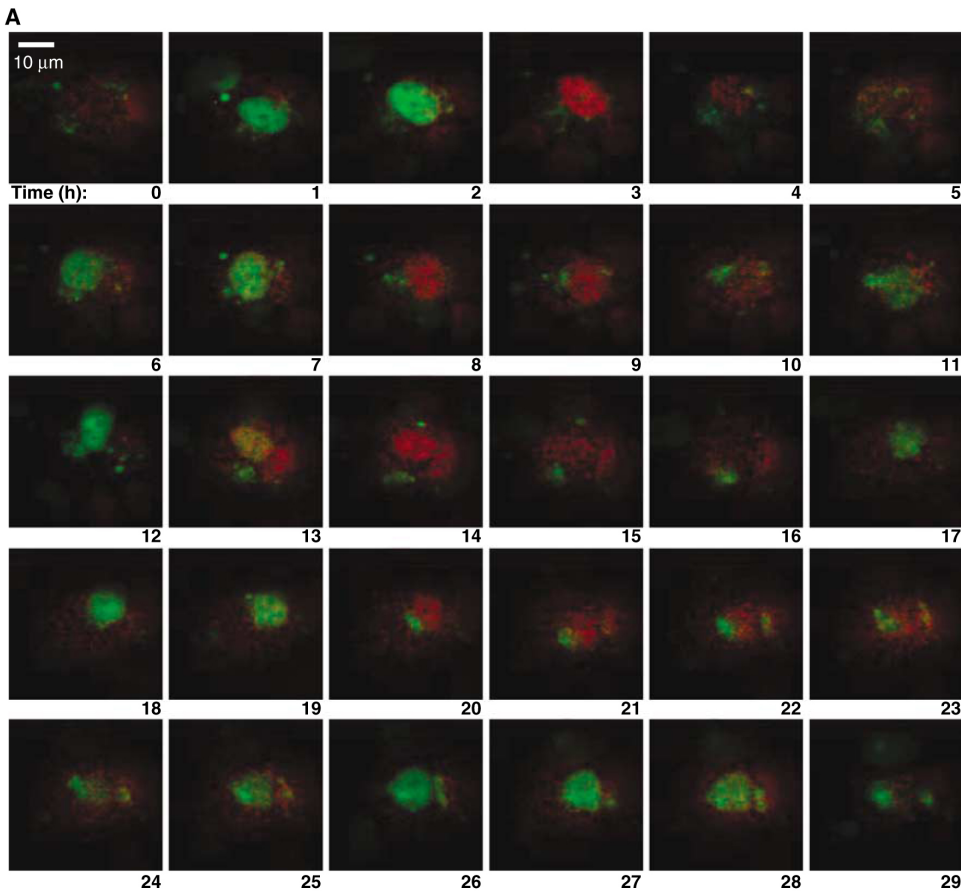

Inputs and outputs

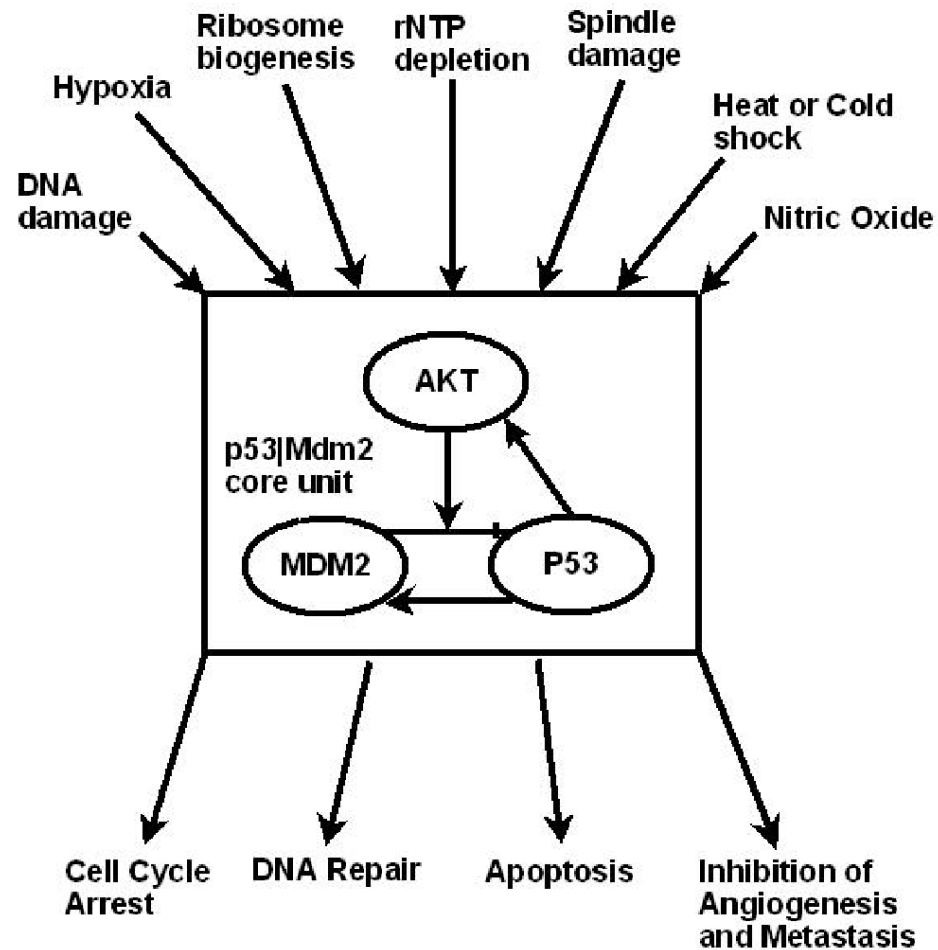

“Our pathway”

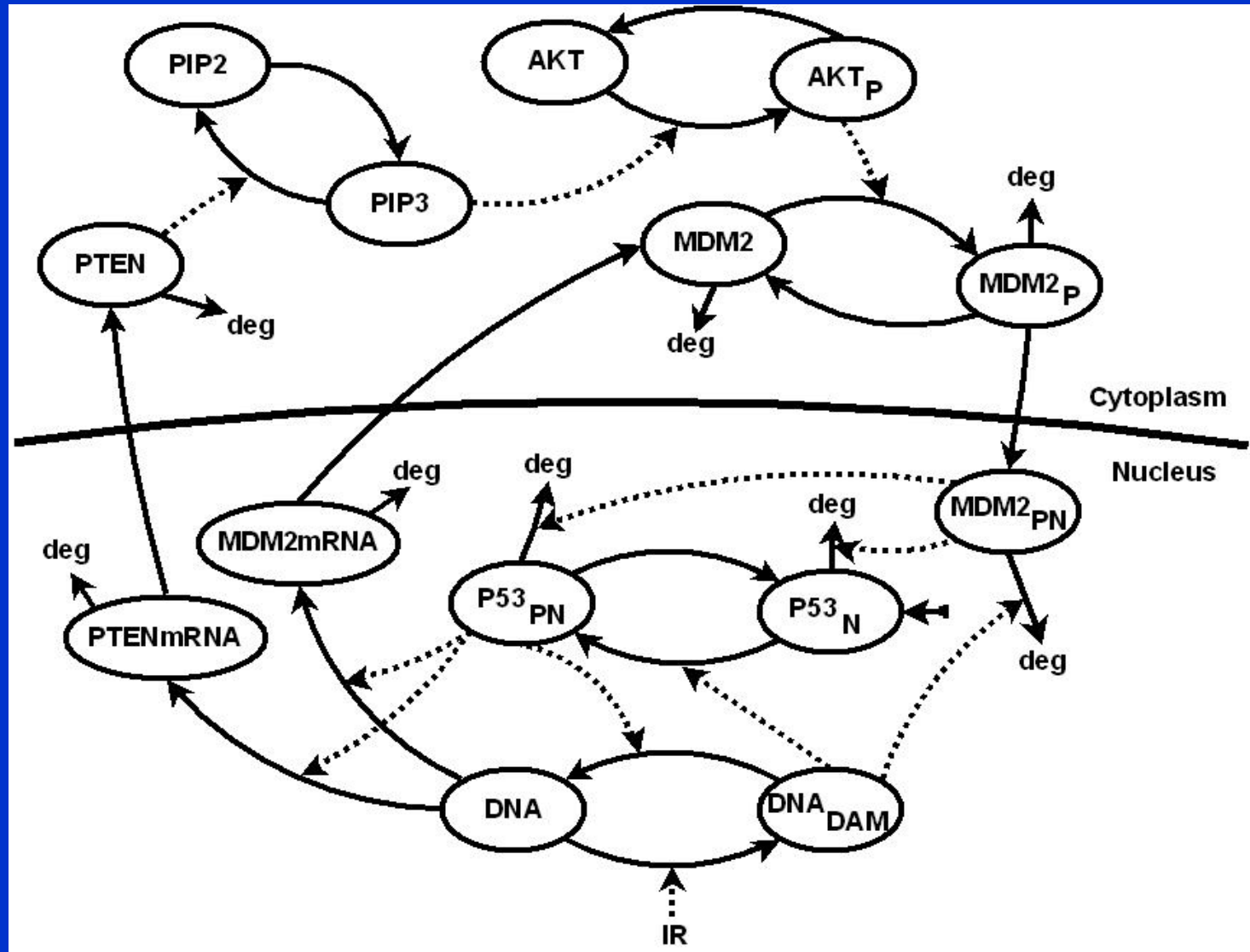

Negative feedback loop

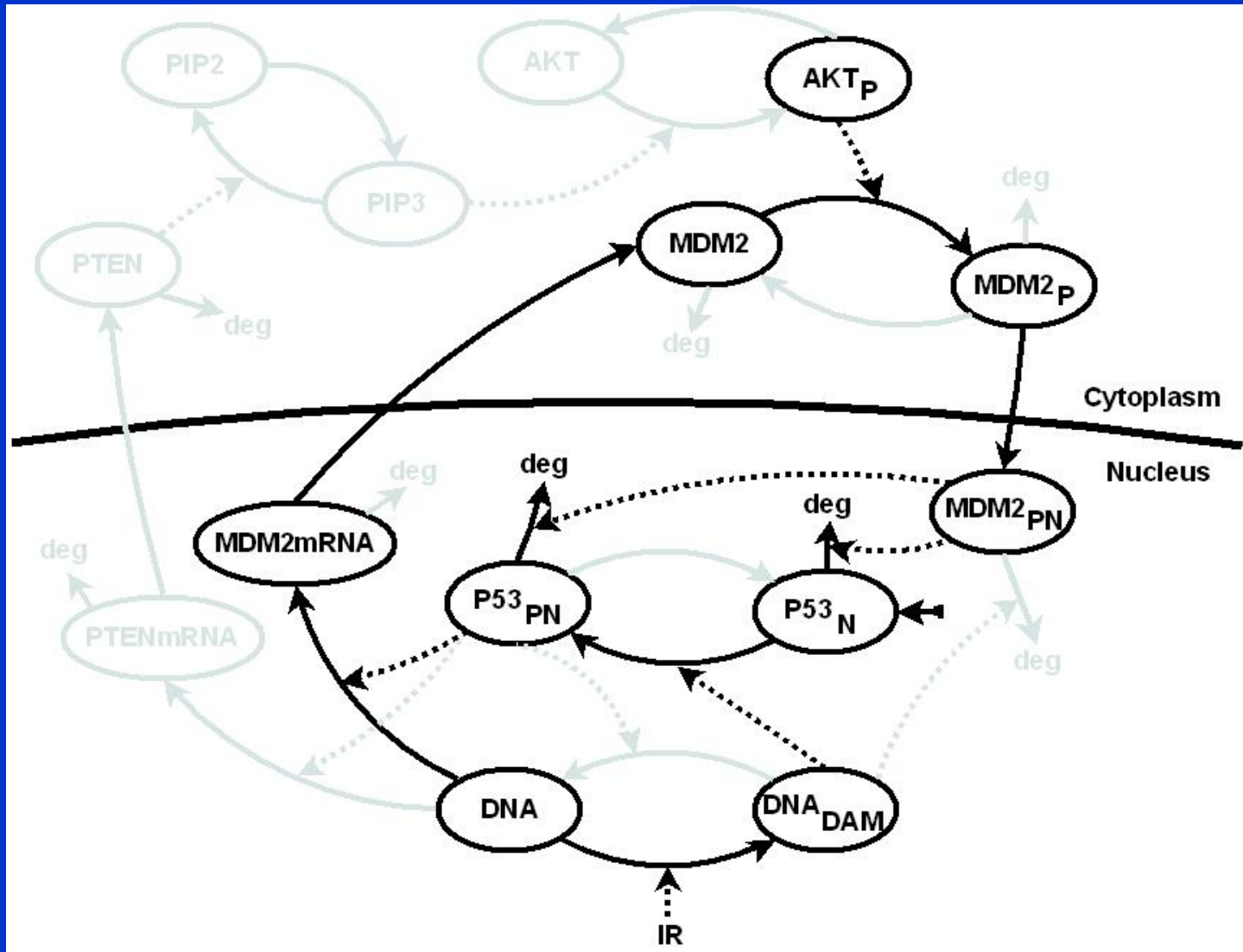

Positive feedback loop

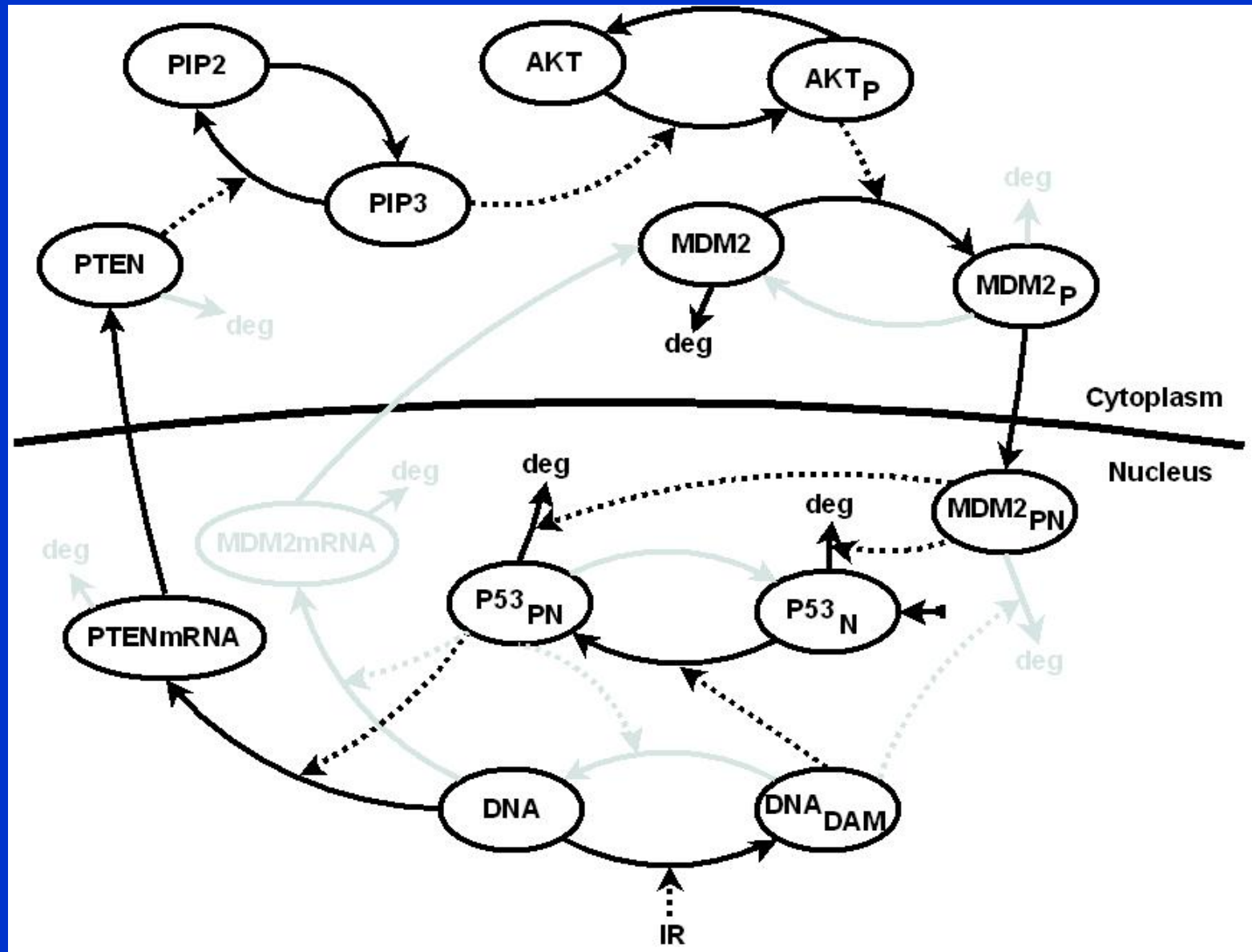

Stochasticity in eukaryotic cell regulation

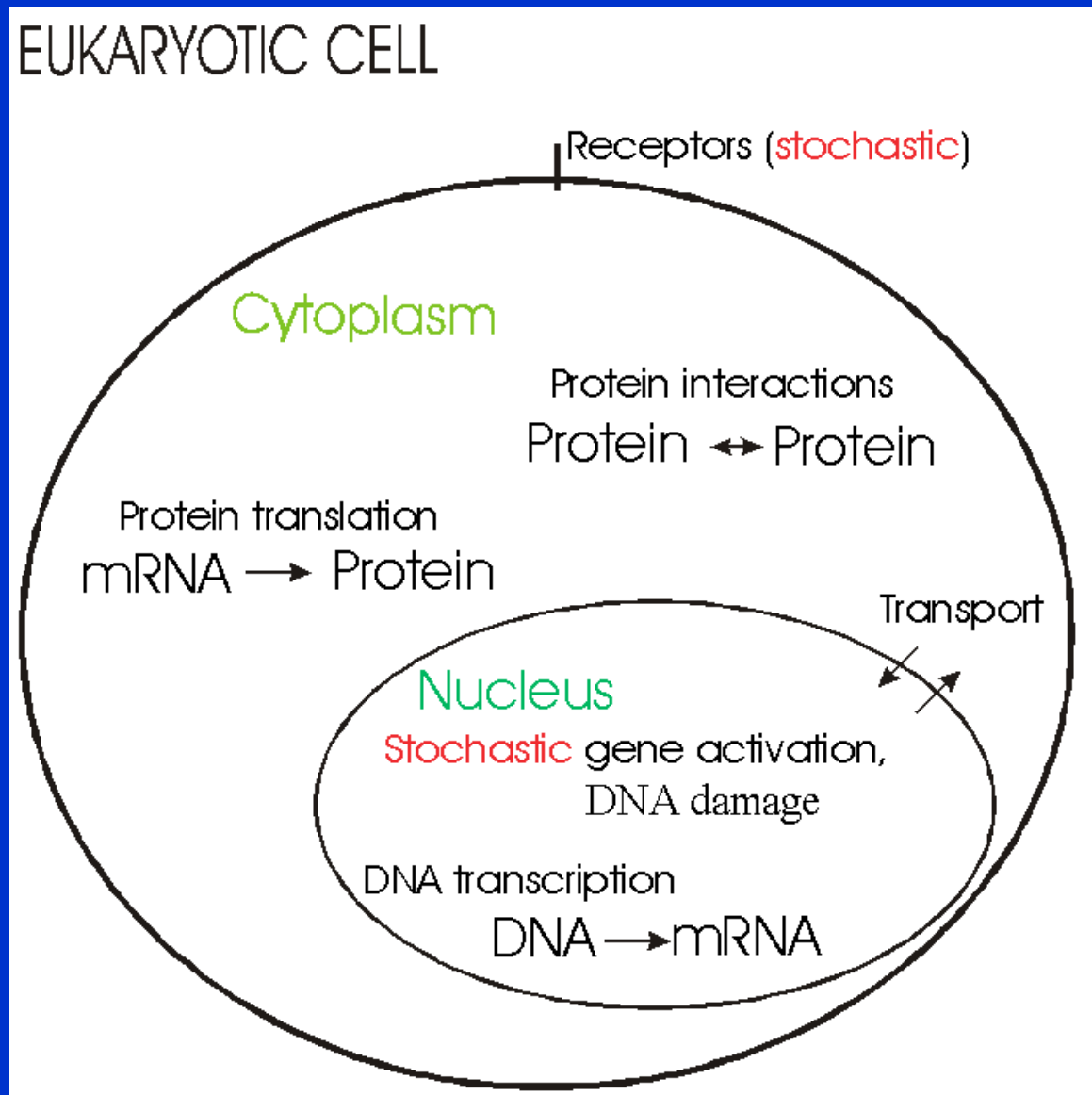

Stochastic gene expression

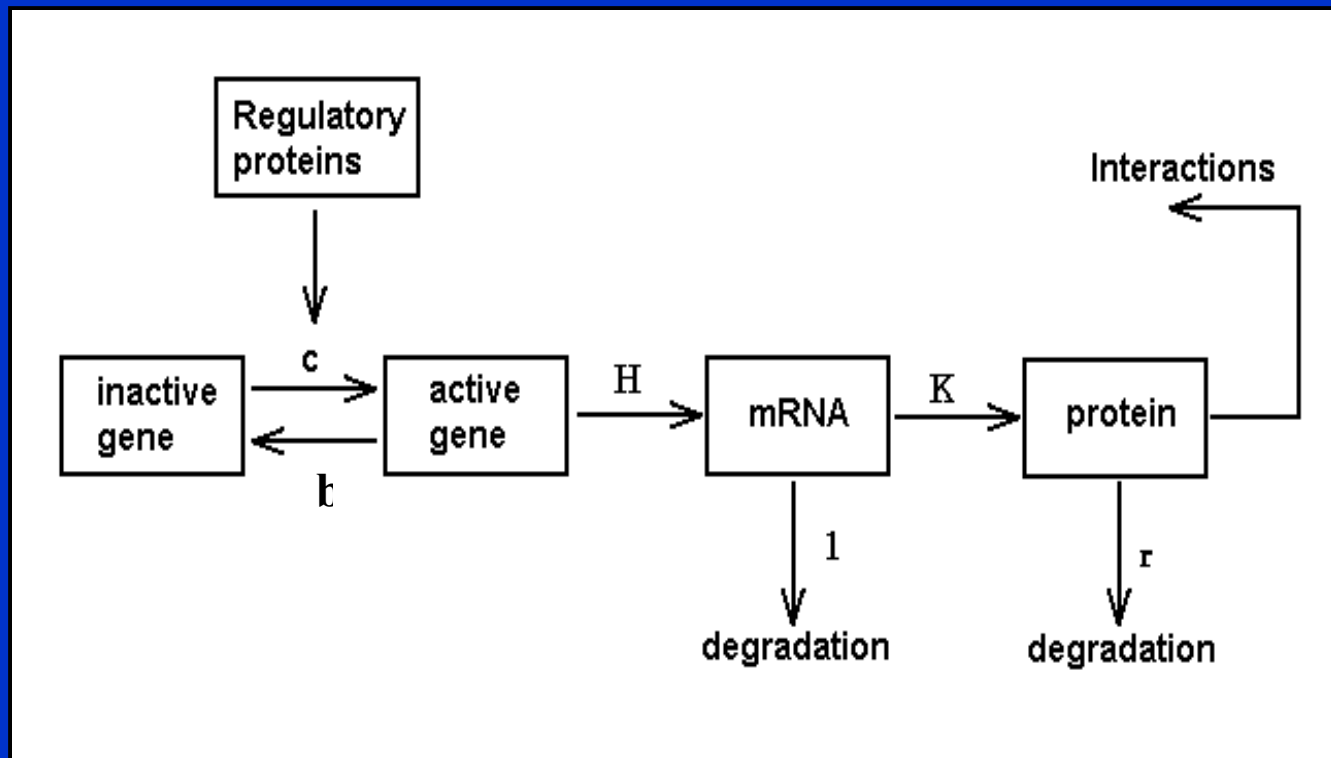

The main steps in gene expression

Transduction amplification pathway

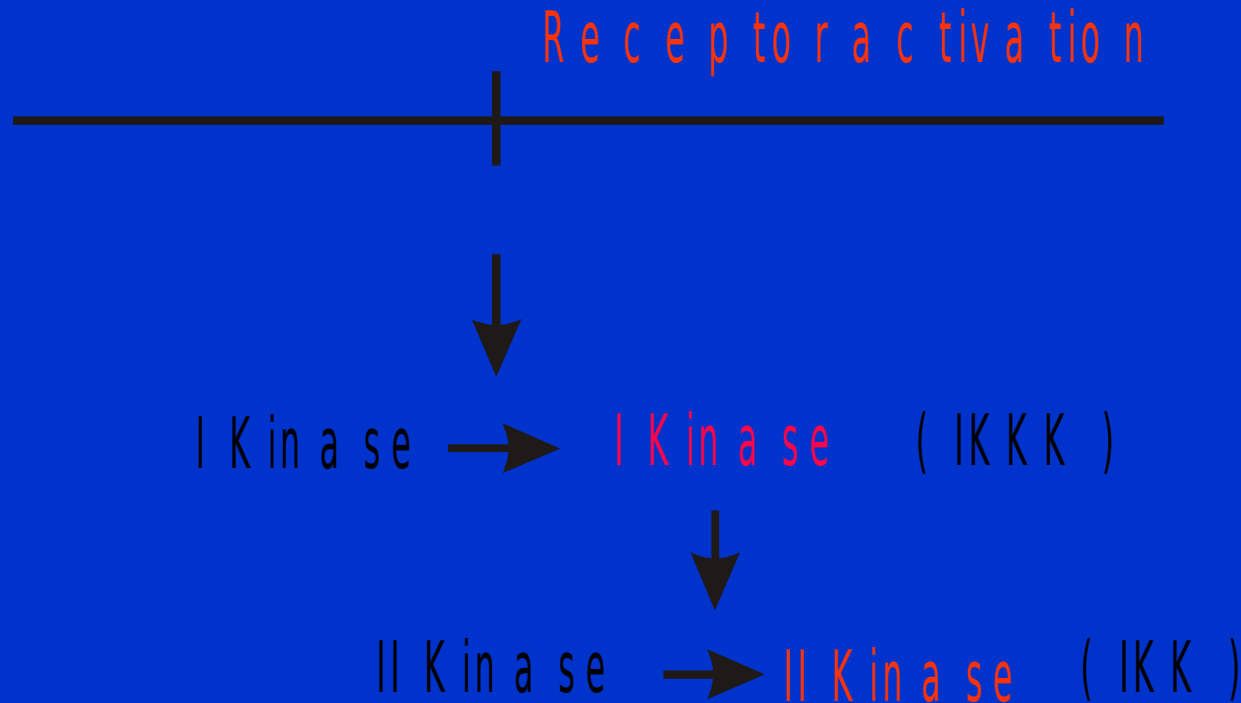

Stochastic receptor activation may result in a large number of II kinase molecules.

No PTEN (positive feedback blocked); No DNA repair Oscillations

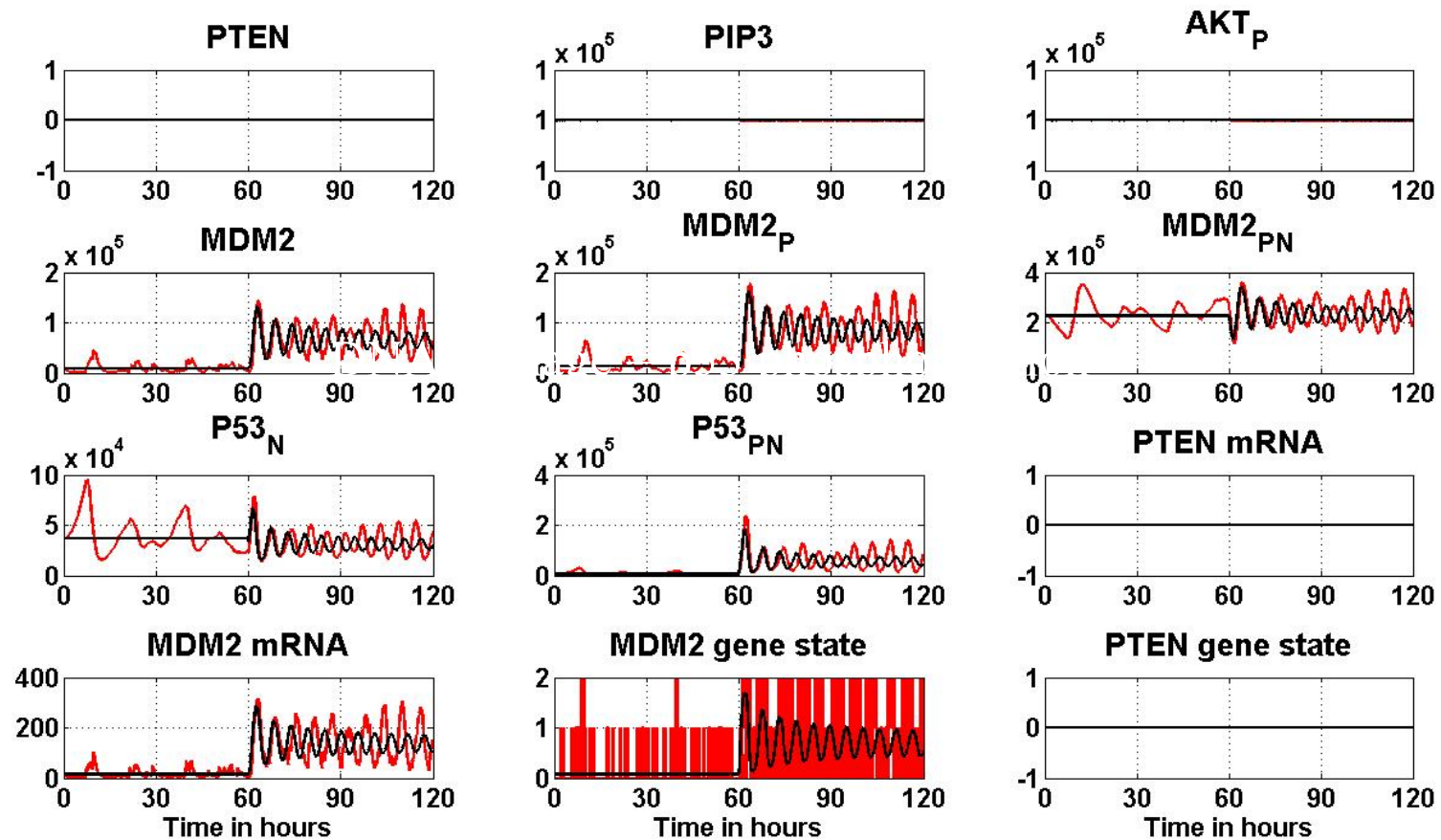

DNA damage = p53 phosphorylation + MDM2 degradation

No PTEN (positive feedback blocked); No DNA repair

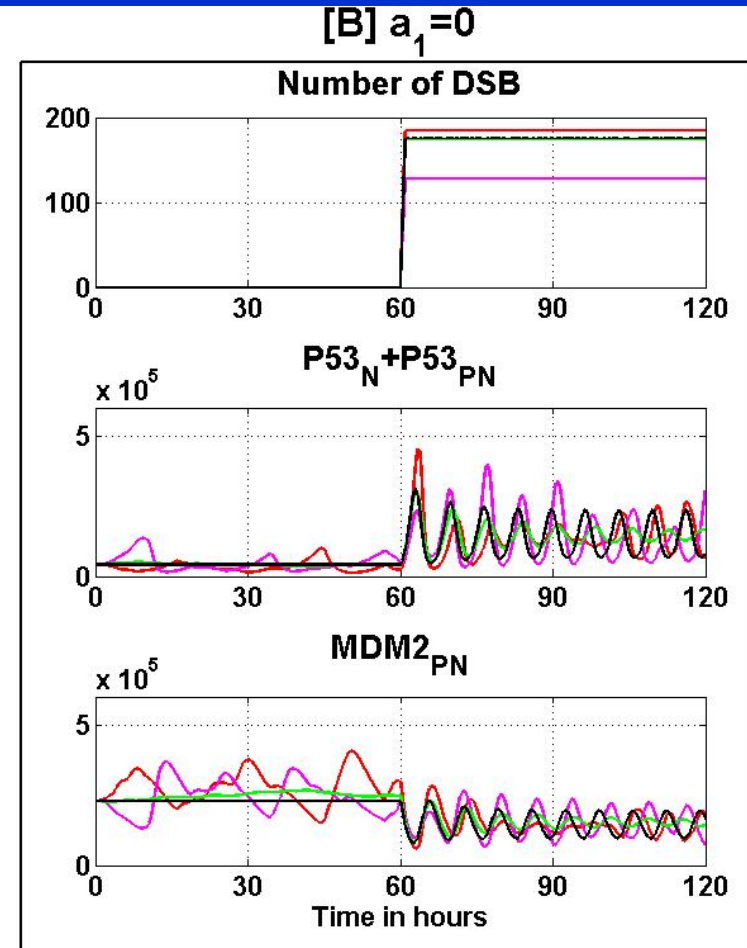
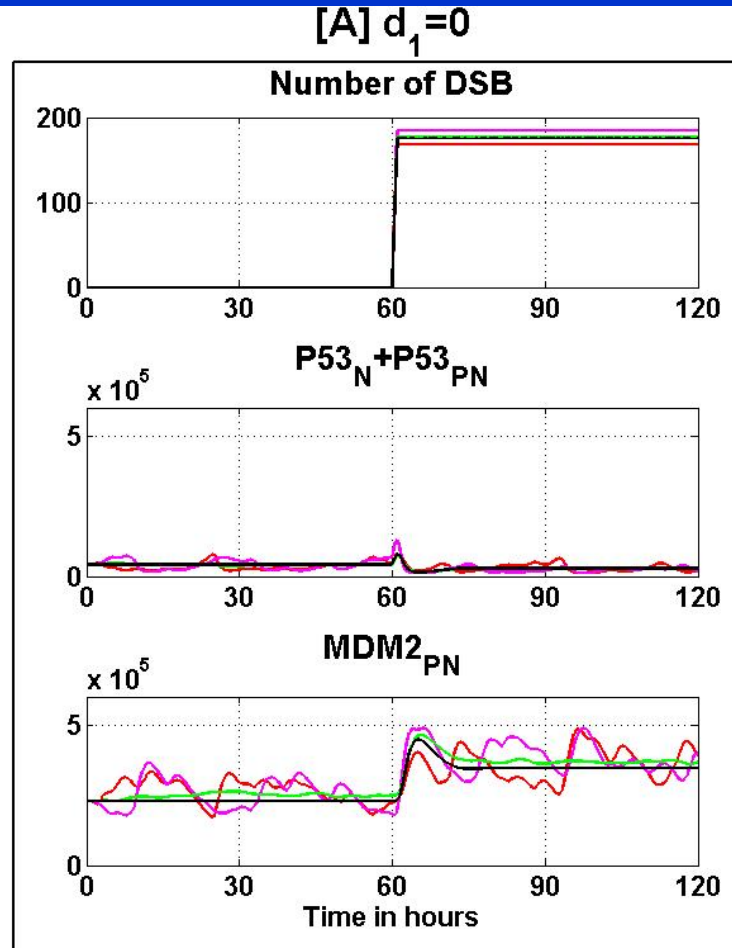

DNA damage = p53 phosphorylation

DNA damage = MDM2 degradation
oscillations

PTEN *ON* (positive feedback active); No DNA repair Apoptosis

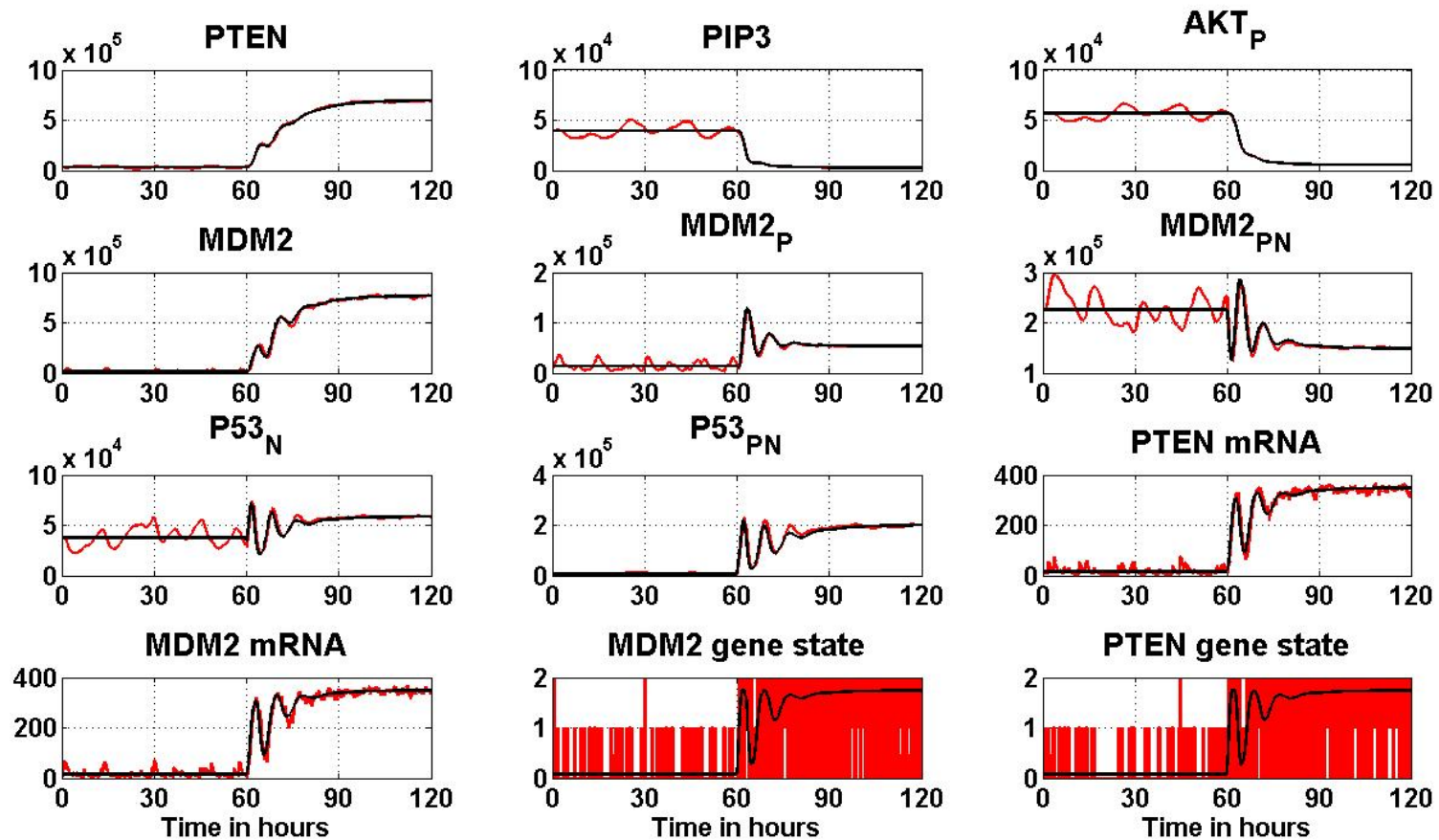

DNA damage = p53 phosphorylation + MDM2 degradation

PTEN *ON* (positive feedback active); No DNA repair

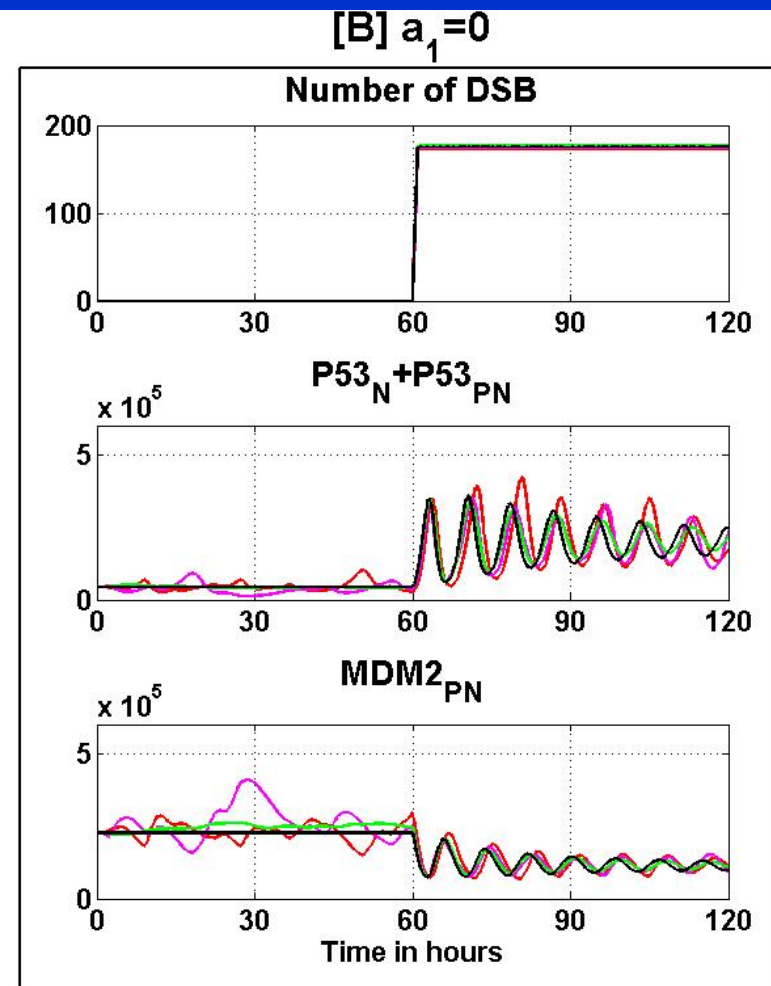
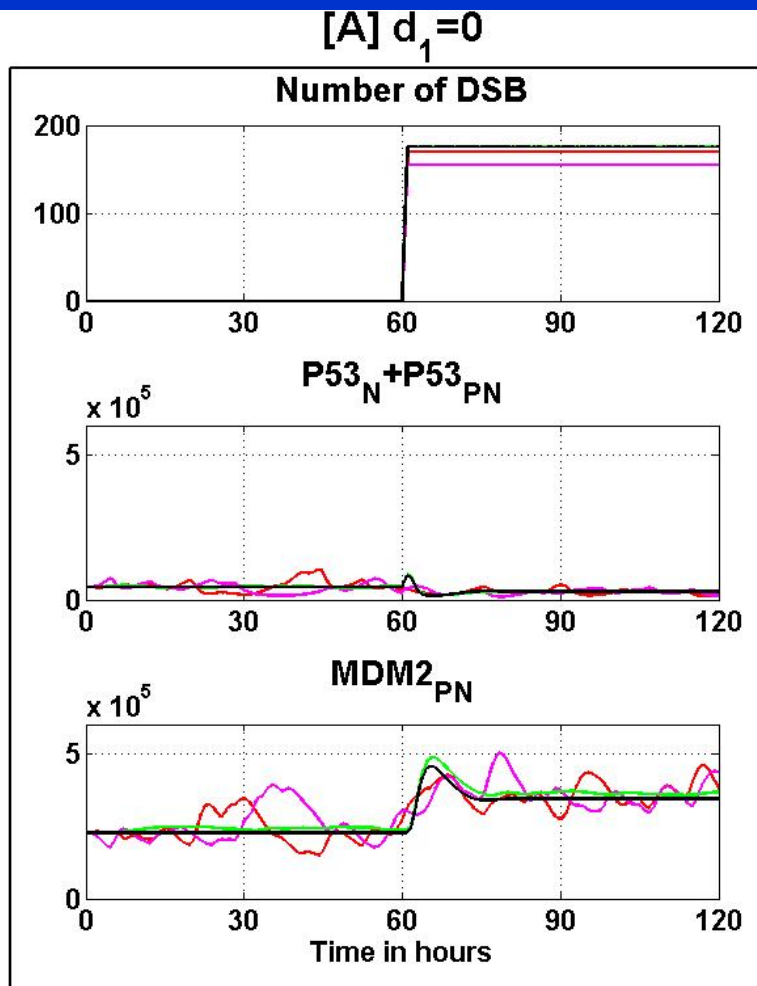

DNA damage = p53 phosphorylation

DNA damage = MDM2 degradation
oscillations

PTEN *ON* (positive feedback active); DNA repair *ON* cell fate decision

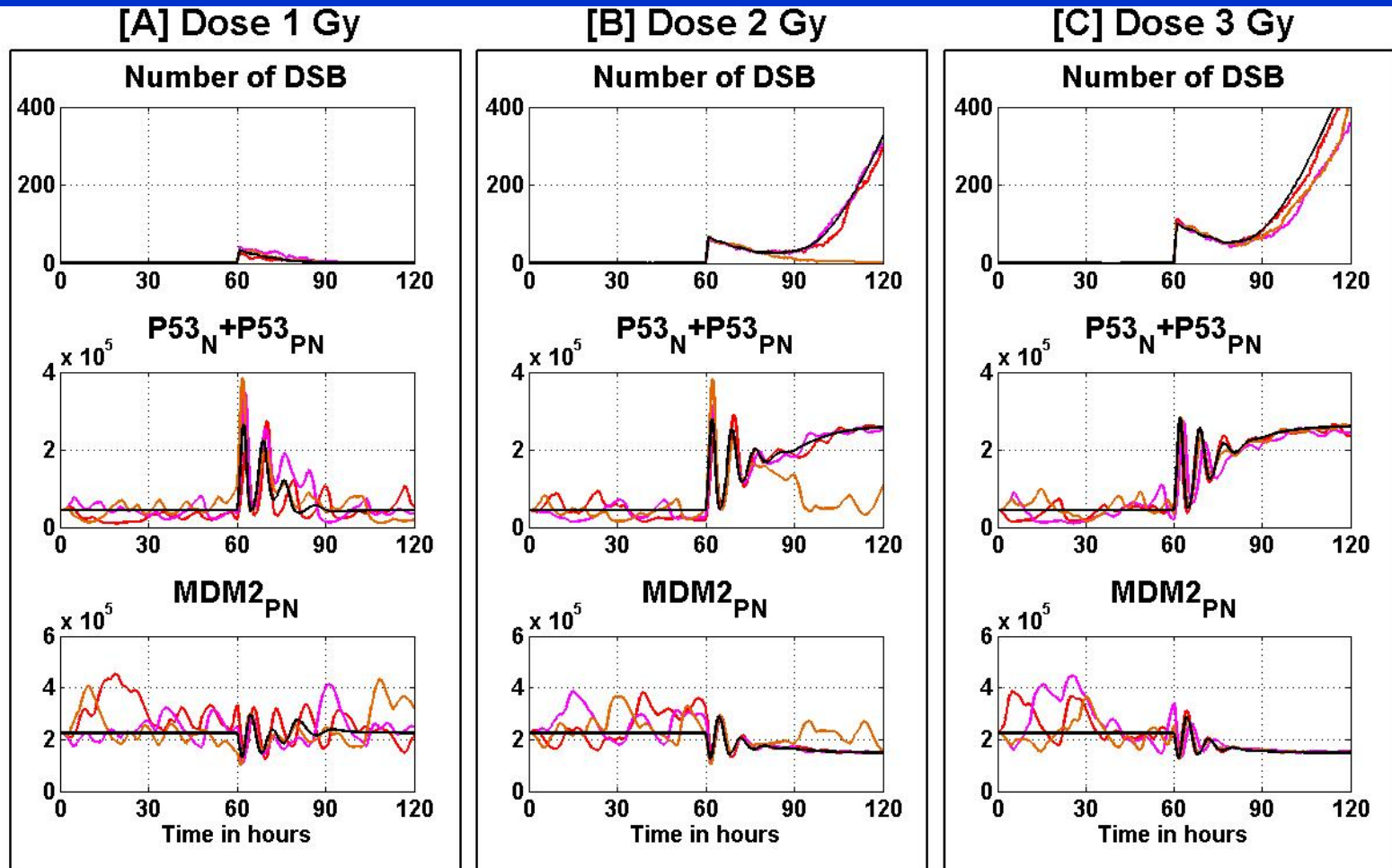

p53 produces proapoptotic factor, which cut DNA

Cell fate decision

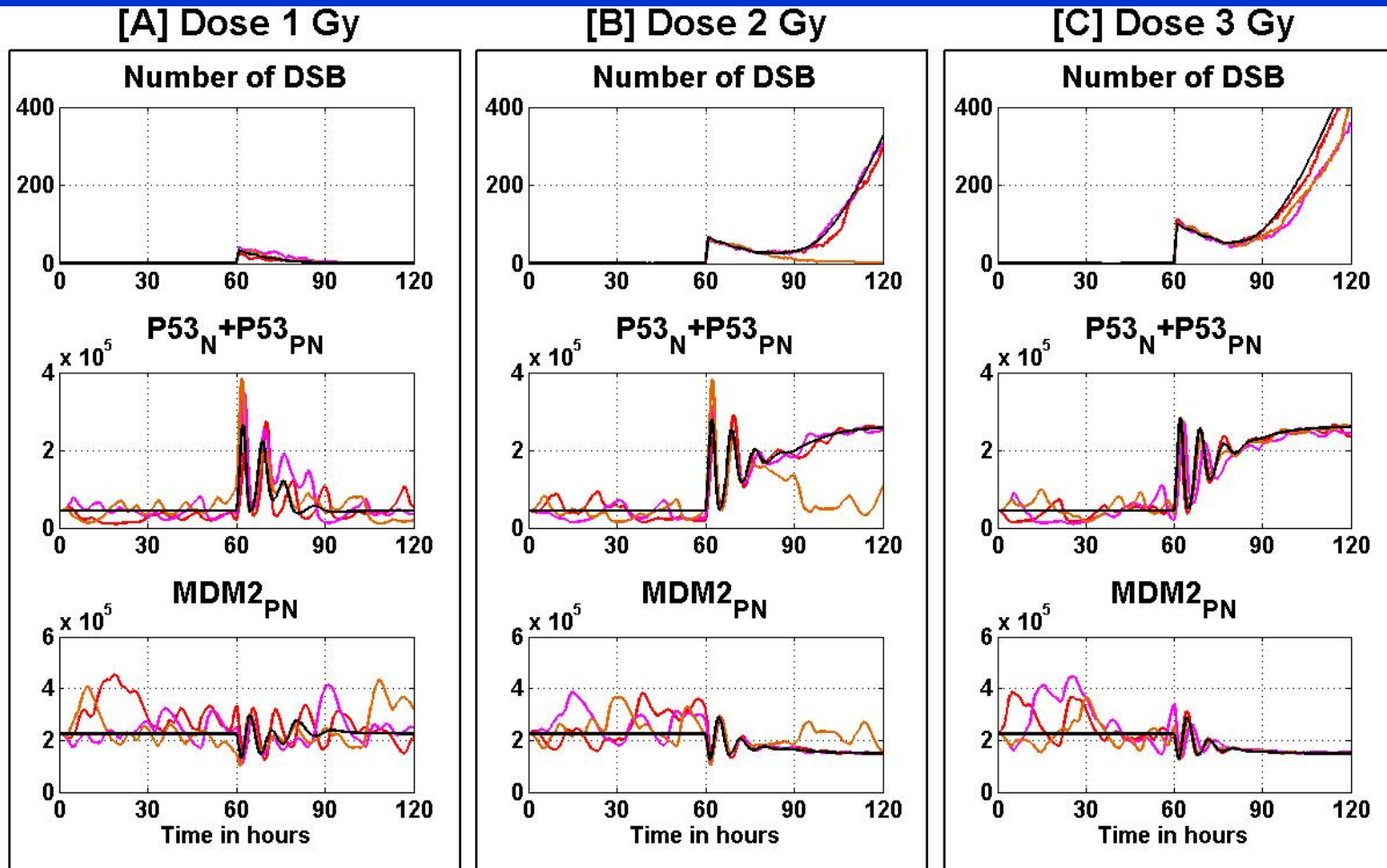

Cell population separates into surviving and apoptotic cells 48 hours after gamma radiation.

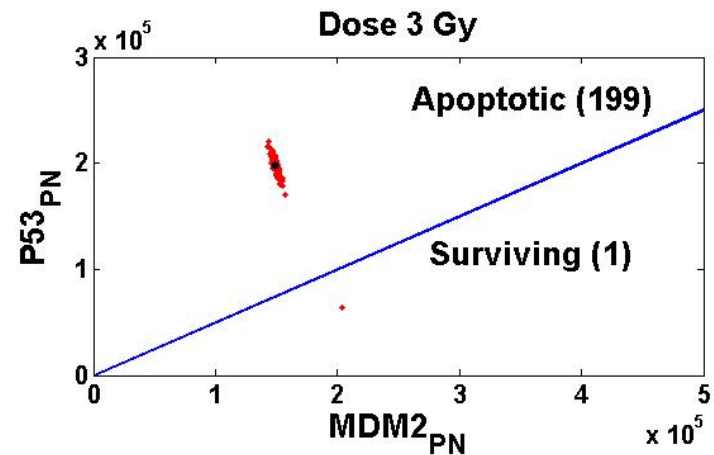
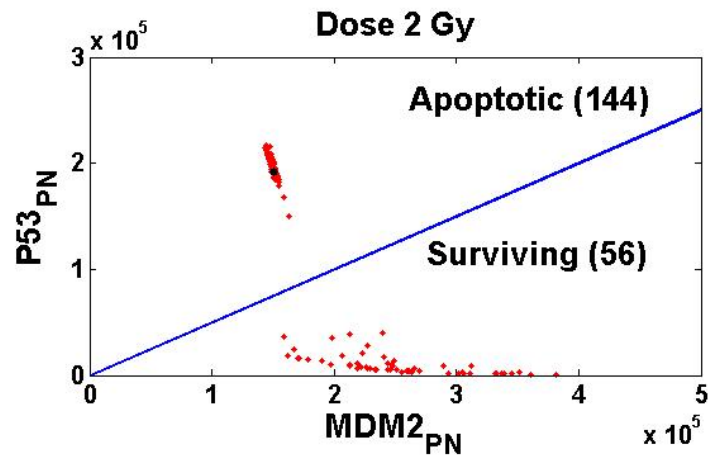
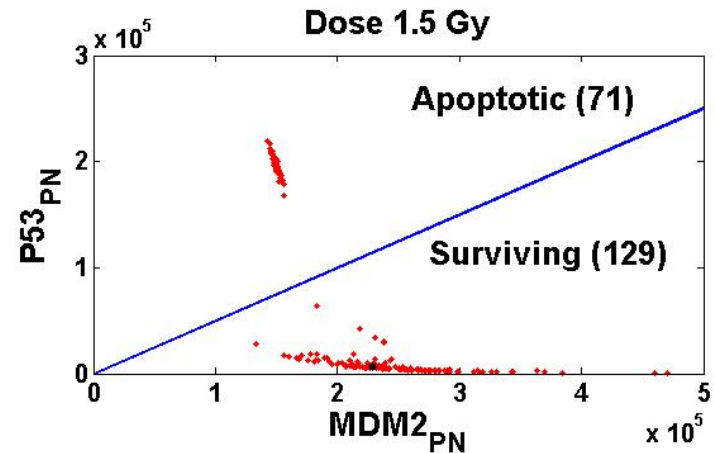
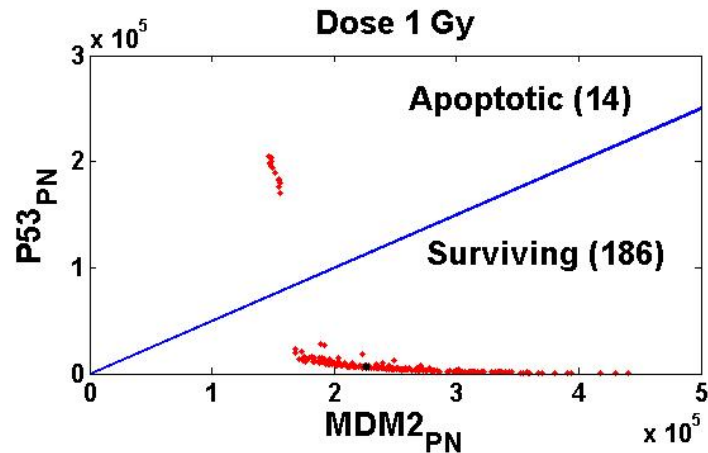

ODEs

$$\frac{d}{dt}PTEN(t) = t_1 PTEN_t(t) - d_2 PTEN(t).$$

$$\frac{d}{dt}PIP_p(t) = a_2 (PIP_{tot} - PIP_p(t)) - c_0 PTEN(t) PIP_p(t).$$

$$\frac{d}{dt}AKT_p(t) = a_3 (AKT_{tot} - AKT_p(t)) PIP_p(t) - c_1 AKT_p(t).$$

$$\begin{aligned} \frac{d}{dt}MDM(t) = & t_0 MDM_t(t) + c_2 MDM_p(t) \\ & - a_4 MDM(t) AKT_p(t) - \left(d_0 + d_1 \frac{N^2(t)}{h_0^2 + N^2(t)} \right) MDM(t). \end{aligned}$$

$$\begin{aligned} \frac{d}{dt} MDM_p(t) &= a_4 MDM(t) AKT_p(t) - c_2 MDM_p(t) - i_0 MDM_p(t) \\ &\quad + e_0 MDM_{pn}(t) - \left(d_0 + d_1 \frac{N^2(t)}{h_0^2 + N^2(t)} \right) MDM_p(t). \end{aligned}$$

$$\frac{d}{dt} MDM_{pn}(t) = i_0 MDM_p(t) - e_0 MDM_{pn}(t) - \left(d_0 + d_1 \frac{N^2(t)}{h_0^2 + N^2(t)} \right) MDM_{pn}(t).$$

$$\begin{aligned} \frac{d}{dt} P53_n(t) &= p_0 - \left(a_0 + a_1 \frac{N^2(t)}{h_0^2 + N^2(t)} \right) P53_n(t) + c_3 P53_{pn}(t) \\ &\quad - (d_3 + d_4 MDM_{pn}^2(t)) P53_n(t). \end{aligned}$$

$$\begin{aligned} \frac{d}{dt} P53_{pn}(t) &= \left(a_0 + a_1 \frac{N^2(t)}{h_0^2 + N^2(t)} \right) P53_n(t) - c_3 P53_{pn}(t) \\ &\quad - (d_5 + d_6 MDM_{pn}^2(t)) P53_{pn}(t). \end{aligned}$$

$$\frac{d}{dt}MDM_t(t) = s_0 (G_{M1} + G_{M2}) - d_7 MDM_t(t).$$

$$\frac{d}{dt}PTEN_t(t) = s_1 (G_{P1} + G_{P2}) - d_8 PTEN_t(t).$$

proapoptotic factor

$$\frac{d}{dt}A(t) = p_1 \frac{q_3 P53_{np}^2(t)}{q_4 + q_3 P53_{np}^2(t)} - d_9 A(t)$$

Transition probabilities governing dynamics of discrete variables; G_M, G_P, N

Gene activation:

$$P^b(t, \Delta t) = \Delta t \times (q_0 + q_1 \times P53_{np}^2(t)).$$

Gene inactivation:

$$P^d(t, \Delta t) = \Delta t \times q_2.$$

DNA damage:

$$P^{DAM}(t, \Delta t) = \Delta t \times d_{DAM} \times R + \Delta t \times a_6 \left(\frac{A(t)}{A_{max}} \right)^4$$

DNA repair:

$$P^{REP}(t, \Delta t) = N(t) \frac{\Delta t \times d_{REP} \times P_A(t)}{N(t) + N_{SAT} \times P_A(t)}$$

Piece-wise deterministic, time continuous Markov process

Numerical implementation

- At the simulation time t for given A_{Mdm2} , A_{PTEN} and NB calculate total propensity function of occurrence of any of the reaction

$$r(t) = r_{DNA}^a + r_{DNA}^d + r_{Mdm2}^a + r_{Mdm2}^d + r_{PTEN}^a + r_{PTEN}^d$$

- Select two random numbers p_1 and p_2 from the uniform distribution on $(0,1)$
- Evaluate the ODE system until time $t+\tau$ such that:

$$\log(p_1) + \int_t^{t+\tau} r(s) ds = 0$$

9. Determine which reaction occurs in time $t+\tau$ using the inequality:

$$\sum_{i=1}^{k-1} r_i(t+\tau) < p_2 * r(t+\tau) \leq \sum_{i=1}^k r_i(t+\tau)$$

where k is the index of the reaction to occur and $r_i(t+\tau)$ individual reaction propensities

5. Replace time $t+\tau$ by t and go back to item 1